

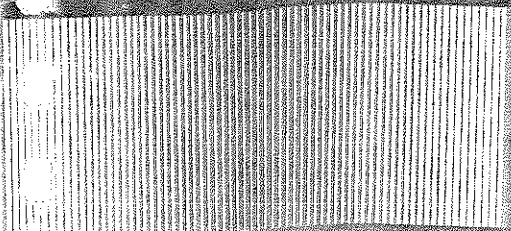

Operator's Manual

TE-072

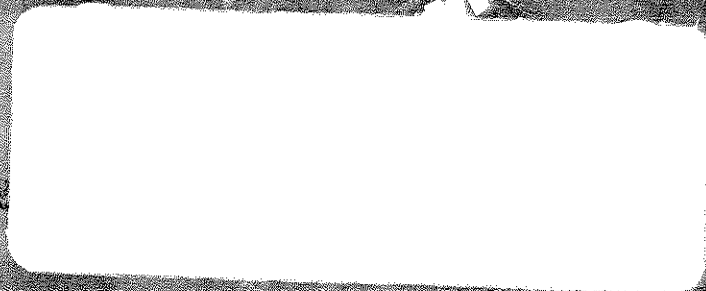

**LeCroy**

*Innovators in Instrumentation*

**OPERATOR'S MANUAL**

**LeCROY DIGITAL OSCILLOSCOPES  
9350 SERIES**

**Revision 1 – March 1994**

# LeCroy

## **Corporate Headquarters**

700 Chestnut Ridge Road  
Chestnut Ridge, NY 10977-6499  
Tel: (914) 425-2000, TWX: 710-577-2832

## **European Headquarters**

2, rue du Pré-de-la-Fontaine  
P.O. Box 341  
1217 Meyrin 1/Geneva, Switzerland  
Tel: (022) 719 21 11, Telex: 419 058

## TABLE OF CONTENTS

### INTRODUCTION

<b>1</b>	<b>Key Features</b>	
<b>2</b>	<b>General Information</b>	
	Initial Inspection	2-1
	Warranty	2-1
	Product Assistance	2-1
	Maintenance Agreements	2-2
	Documentation Discrepancies	2-2
	Service Procedure	2-2
	Return Procedure	2-2
<b>3</b>	<b>Instrument Architecture</b>	
	Architecture	3-1
	ADCs and Memories	3-2
	Trigger	3-3
	Automatic Calibration	3-3
	Display	3-3
	Manual/Remote Control	3-4
<b>4</b>	<b>Installation</b>	
	Operating Environment	4-1
	Power Requirements	4-1
	Safety Information	4-1
	Power On	4-2
<b>5</b>	<b>Front-panel Overview</b>	
<b>6</b>	<b>Control of the Oscilloscope</b>	
	Active Buttons	6-1
	Switching between Menus	6-1
	Performing Actions	6-1
	Setting Menu Options	6-2
	General Instrument Reset	6-2

**TABLE OF CONTENTS**

---

**DISPLAY**

**7 Display Overview**

Real-Time Clock Field (1)	7-1
Displayed Trace Field (2)	7-1
Trigger Level Field (3)	7-1
Acquisition Summary Field (4)	7-1
Trigger Delay Field (5)	7-2
Trigger Configuration Field (6)	7-2
Time and Frequency Field (7)	7-2
Trigger Status Field (8)	7-2
Grid (9)	7-3
Menu Field (10)	7-3
Message Field (11)	7-3

**TIMEBASE + TRIGGER**

**8 Timebase + Trigger Capabilities**

Timebase Capabilities	8-1
Single Shot	8-1
Random Interleaved Sampling	8-2
Roll Mode	8-3
Sequence Mode	8-3
Trigger Capabilities	8-5
EDGE Trigger	8-5

**9 Timebase + Trigger Direct Controls**

STOP	9-1
AUTO	9-1
NORM	9-2
SNGL	9-2
AUTO SETUP	9-2
DELAY	9-3
ZERO	9-3
TIME/DIV	9-3
LEVEL	9-3
TIMEBASE SETUP	9-3
TRIGGER SETUP	9-3

## TABLE OF CONTENTS

<b>10</b>	<b>Timebase Setup</b>	
	Timebase Setup Menu	10-1
	More on Channel Use	10-2
	Sequence Mode	10-3
	External Clock	10-5
<b>11</b>	<b>Trigger Setup</b>	
	How the Trigger Modes Overlap	11-1
	Choosing the Trigger Mode	11-1
	EDGE Trigger	11-2
	Trigger Symbols	11-3
	SMART Trigger	11-4
	GLITCH Trigger	11-5
	Interval Trigger	11-8
	TV Trigger	11-10
	State Qualified Trigger	11-13
	Edge Qualified Trigger	11-15
	Dropout Trigger	11-17
	Pattern Trigger	11-19
	Trigger Symbols	11-22

## CHANNELS

<b>12</b>	<b>Channels Direct Controls</b>	
	2-Channel Oscilloscopes	
	Trace ON/OFF	12-1
	Offset	12-1
	Find	12-1
	Volts/Div	12-1
	VAR	12-2
	Coupling	12-2
	4-Channel Oscilloscopes	
	Trace ON/OFF	12-3
	Select Channel	12-3
	Offset	12-3
	Find	12-3
	Volts/Div	12-4
	VAR	12-4
	Coupling	12-4

## TABLE OF CONTENTS

<b>13</b>	<b>Coupling</b>	
	Coupling Menu	13-1
	ProBus System	13-2
	More on Coupling	13-3
	Probes	13-3
<b>ZOOM + MATH</b>		
<b>14</b>	<b>Zoom + Math Capabilities</b>	
	Zoom	14-1
	Waveform Mathematics	14-2
<b>15</b>	<b>Zoom + Math Direct Controls</b>	
	Trace ON/OFF	15-1
	Select Trace	15-1
	↔ Position	15-1
	↑ Position	15-1
	↔ Zoom	15-2
	↑ Zoom	15-2
	Reset	15-2
	Math Setup	15-2
<b>16</b>	<b>Math Setup</b>	
	How to use Math	16-1
	Standard and Optional Processing Packages	16-1
	Setup Menu for Zoom	16-3
	Setup Menu for Arithmetic	16-4
	Setup Menu for Average	16-5
	Setup Menu for Enhanced Resolution	16-7
	Setup Menu for Extrema	16-8
	Setup Menu for FFT	16-10
	FFT Interruption (Abort)	16-10
	Setup Menu for FFT Average	16-11
	Setup Menu for Functions	16-12
	Setup Menu for Rescale	16-14

**TABLE OF CONTENTS**

**MENU CONTROLS**

**17 Menu Buttons & Knobs**

Menu Buttons	17-1
Menu Knobs	17-1
DISPLAY	17-2
UTILITIES	17-2
WAVEFORM STORE	17-2
WAVEFORM RECALL	17-2
CURSORS/MEASURE	17-2
PANEL SETUPS	17-2
SCREEN DUMP	17-2
CLEAR SWEEPS	17-3
General Instrument Reset	17-3

**18 Display**

Standard Display vs. XY Display	18-1
Persistence Display	18-2
Screen Presentation	18-3
Standard Display	18-5
XY Display	18-6
More Display	18-7

**19 Utilities**

Utilities Main Menu	19-1
Hardcopy Setup Menu	19-2
Internal Printer Setup Menu	19-3
Time/Date Menu	19-4
GPIB & RS232 Menu	19-5
RS-232-C Connector	19-6
Memory Card Utilities Menu	19-7
Memory Card & Floppy Disk Structure	19-8
Floppy Disk Utilities	19-10
Copy Files Menu	19-13
Special Modes Menu	19-14
CAL BNC Out Menu	19-15



## TABLE OF CONTENTS

---

<b>20</b>	<b>Waveform Store</b>	
	Waveform Store Menu	20-1
<b>21</b>	<b>Waveform Recall</b>	
	Recall from Internal Memory	21-1
	Recall from Memory Card or Floppy Disk	21-2
<b>22</b>	<b>Cursors/Measure</b>	
	Cursors in Standard Display	22-1
	Cursors in Persistence Display	22-1
	Cursors in XY Display	22-1
	Automatic Measurements	22-3
	Pass/Fail	22-3
	Parameter Information & Warning Symbols	22-6
	Cursors Menu	22-7
	Parameters Menu	22-8
	Standard Voltage Parameters	22-9
	Standard Time Parameters	22-10
	Custom Parameters	22-11
	Adding/Deleting Custom Parameters	22-12
	Parameters Requiring Setup	22-13
	Parameters Requiring Setup (Customize)	22-14
	Pass/Fail Testing	22-15
	Pass/Fail Menu	22-16
	Change Test on Parameters	22-17
	Change Limits for Test on Parameters	22-18
	Change Test on Mask	22-19
	Generate Mask from Waveform	22-20
	Recall Mask from Card or Disk	22-21
	Set Pass/Fail Actions	22-22
<b>23</b>	<b>Panel Setups</b>	
	Panel Setups Menu	23-1
	Recall Setup Menu	23-2
	Recall Setup from Card or Disk	23-3

## 2 General Information

## INTRODUCTION

### INITIAL INSPECTION

It is recommended that the shipment be thoroughly inspected immediately upon delivery to the purchaser. All material in the container should be checked against the enclosed Packing List. LeCroy cannot accept responsibility for shortages in comparison with the Packing List unless notified promptly. If the shipment is damaged in any way, please contact the Customer Service Department or local field office immediately.

### WARRANTY

LeCroy warrants its oscilloscope products to operate within specifications under normal use for a period of two years from the date of shipment. Spares, replacement parts and repairs are warranted for 90 days. The instrument's firmware is thoroughly tested and thought to be functional, but is supplied "as is" with no warranty of any kind covering detailed performance. Products not manufactured by LeCroy are covered solely by the warranty of the original equipment manufacturer.

In exercising this warranty, LeCroy will repair or, at its option, replace any product returned to the Customer Service Department or an authorized service facility within the warranty period, provided that the warrantor's examination discloses that the product is defective due to workmanship or materials and that the defect has not been caused by misuse, neglect, accident or abnormal conditions or operation.

The purchaser is responsible for transportation and insurance charges for the return of products to the servicing facility. LeCroy will return all in-warranty products with transportation prepaid.

This warranty is in lieu of all other warranties, expressed or implied, including but not limited to any implied warranty of merchantability, fitness, or adequacy for any particular purpose or use. LeCroy shall not be liable for any special, incidental, or consequential damages, whether in contract or otherwise.

### PRODUCT ASSISTANCE

Answers to questions concerning installation, calibration, and use of LeCroy equipment are available from the Customer Service Dept., 700 Chestnut Ridge Road, Chestnut Ridge, New York 10977-6499, U.S.A., tel. (914) 578-6061, and 2, rue du Pré-de-la-Fontaine, 1217 Meyrin 1, Geneva, Switzerland, tel. (41) 22/719 21 11, or your local field engineering office.

## INTRODUCTION

---

### **MAINTENANCE AGREEMENTS**

LeCroy offers a selection of customer support services. Maintenance agreements provide extended warranty and allow the customer to budget maintenance costs after the initial two year warranty has expired. Other services such as installation, training, enhancements and on-site repair are available through specific Supplemental Support Agreements.

### **DOCUMENTATION DISCREPANCIES**

LeCroy is committed to providing state-of-the-art instrumentation and is continually refining and improving the performance of its products. While physical modifications can be implemented quite rapidly, the corrected documentation frequently requires more time to produce. Consequently, this manual may not agree in every detail with the accompanying product. There may be small discrepancies in the values of components for the purposes of pulse shape, timing, offset, etc., and, occasionally, minor logic changes. Where any such inconsistencies exist, please be assured that the unit is correct and incorporates the most up-to-date circuitry. In a similar way the firmware may undergo revision when the instrument is serviced. Should this be the case, manual updates will be made available as necessary.

### **SERVICE PROCEDURE**

Products requiring maintenance should be returned to the Customer Service Department or authorized service facility. LeCroy will repair or replace any product under warranty at no charge. The customer is responsible for transportation charges to the factory. All in-warranty products will be returned to the customer with transportation prepaid.

For all LeCroy products in need of repair after the warranty period, the customer must provide a Purchase Order Number before repairs can be initiated. The customer will be billed for parts and labor for the repair, as well as for shipping.

### **RETURN PROCEDURE**

To determine your nearest authorized service facility, contact the Customer Service Department or your field office. All products returned for repair should be identified by the model and serial numbers and include a description of the defect or failure, name and phone number of the user, and, in the case of products returned to the factory, a Return Authorization Number (RAN). The RAN may be obtained by contacting the Customer Service Department in New York, tel. (914) 578-6061, in Geneva, tel. (41) 22/719 21 11, or your nearest sales office.

**INTRODUCTION**

Return shipments should be made prepaid. LeCroy will not accept C.O.D. or Collect Return Shipments. Air-freight is generally recommended. Wherever possible, the original shipping carton should be used. If a substitute carton is used, it should be rigid and be packed such that the product is surrounded with a minimum of four inches of excelsior or similar shock-absorbing material. In addressing the shipment, it is important that the Return Authorization Number be displayed on the outside of the container to ensure its prompt routing to the proper department within LeCroy.

### 3 Instrument Architecture

## INTRODUCTION

#### ARCHITECTURE

The instrument features 500 Megasample/s 8-bit ADCs for each channel. Faster sample rates can be achieved by combining two or four channels, bringing the sample rate to a maximum of 1 GS/s on 2-channel models and 2 GS/s on 4-channel<sup>1</sup> models. When all available channels are used, the waveform acquisition memories consist of 25K data points per channel — on Models M and L respectively 100K and 2M. More acquisition memory — up to 4M on 2-channel L models and up to 8M on 4-channel L models — can be achieved by combining two or four channels (see Appendix A, "Acquisition Memories"). Four memories are available for temporary storage and four additional memories are available for waveform zooming and processing. The central processor is a Motorola microprocessor which performs computations and controls the oscilloscope's operation.

All front-panel knobs and buttons are constantly monitored by the front-panel processor, and front-panel setups are rapidly reconfigured via the unit's internal 16-bit bus. Data are quickly processed according to the selected front-panel setups, and are transferred to the display memory for direct waveform display or stored in the reference memories.

The main microprocessor controls the unit's GPIB (IEEE-488) remote control port, as well as the RS-232-C port which is used to directly interface the oscilloscope to a digital plotter, printer, remote terminal or other low-speed device.

<sup>1</sup>Achieved by means of an external adaptor — the PP092. When this adaptor is plugged in, the only sample rate available will be 2 GS/s. Slower speeds for slower timebases will not be available as long as the PP092 is in place.

## INTRODUCTION

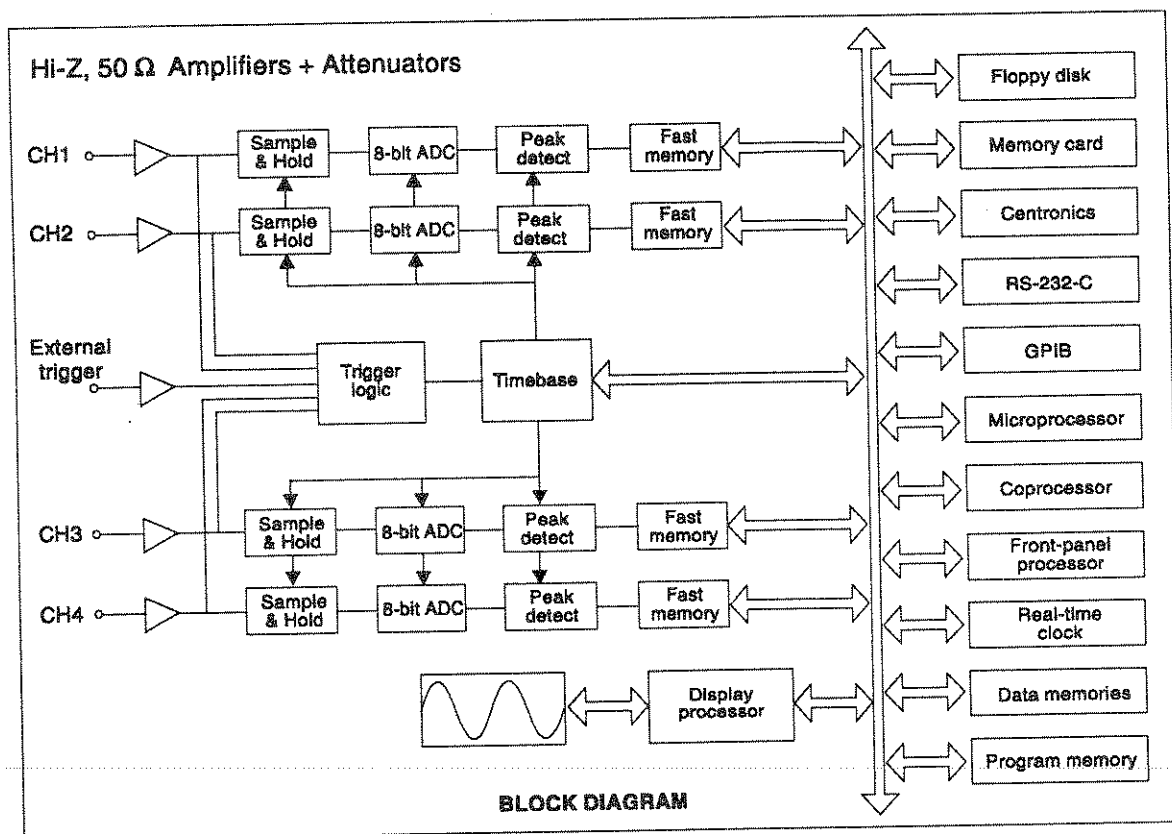

### ADCs AND MEMORIES

Each of the oscilloscope's identical input channels is equipped with a 500 megasample/s, 8-bit ADC. This multiple ADC architecture ensures absolute amplitude and phase correlation, maximum ADC performance for multi-channel acquisitions, large record lengths and excellent time resolution. In addition, faster sample rates can be achieved by combining two or four channels, bringing the sample rate to a maximum of 1 GS/s on 2-channel models and 2 GS/s on 4-channel models.

Acquisition memories of up to 2M simplify transient capture by providing long waveform records that capture waveforms even when trigger timing or signal speed is uncertain. More acquisition memory — up to 4M on 2-channel models and up to 8M on 4-channel models — can be achieved by combining two or four channels (see

Appendix A, "Acquisition Memories"). In addition, a special expansion facility magnifies waveforms by up to 20000 times the selected timebase speed.

Repetitive signals can be acquired and stored at a Random Interleaved Sampling (RIS) rate of 10 gigasamples/s. RIS is a high-precision digitizing technique that enables measurement of repetitive signals to the instrument's full bandwidth, with an effective sampling interval of 100 ps and measurement resolution of 10 ps. (See Chapter 8, Timebase + Trigger Capabilities).

#### TRIGGER

The digitally-controlled trigger system offers an extensive range of trigger capabilities. Front-panel and menu controls allow selection of the appropriate trigger function for the signal.

In the standard trigger mode the front-panel controls are used to select and set parameters such as pre- and post-trigger recording, sequence and roll modes, in addition to the Auto, Normal and Single modes. The trigger source can be any of the input channels, line or external. The coupling is selected from AC, LF REJECT, HF REJECT, HF, and DC, and the slope from positive, negative, and window. (See Chapter 8, Timebase + Trigger Capabilities).

#### AUTOMATIC CALIBRATION

The oscilloscope has an automatic calibration facility that ensures overall vertical accuracy of  $\pm 2\%$  of full scale and a timebase interpolator accuracy of 15 ps RMS for the unit's crystal-controlled timebase.

Vertical gain and offset calibration take place each time the Volts/div is modified. In addition, periodic calibration is performed to ensure long term stability at the current setting.

#### DISPLAY

The large 12.5 × 17.5 cm (9-inches diagonal) screen displays waveforms with enhanced resolution and serves as an interactive, user-friendly interface via a set of pushbuttons located immediately to the right of the CRT.

The oscilloscope displays up to four waveforms, while simultaneously reporting the parameters controlling signal acquisition. The screen also presents internal status and measurement results, as well as operational, measurement, and waveform analysis menus.

A hard copy of the screen is available via the unit's front-panel screen-dump button.

## INTRODUCTION

---

### MANUAL/REMOTE CONTROL

The layout of the front-panel and operation will be very familiar to users of analog oscilloscopes. The "analog" feel is emphasized by rapid instrument response and the fact that waveforms are presented instantly on the high-resolution screen.

The oscilloscope has also been designed for remote control operation in automated testing and computer-aided measurement applications. The entire measurement process, including cursor and pulse parameter settings, dynamic modification of front-panel settings, and display organization, can be controlled via the rear-panel GPIB (IEEE-488) and RS-232-C ports.

Four front-panel setups can be stored and recalled either manually or by remote control, thus ensuring rapid front-panel configuration. When the power is switched off, the current front-panel setting is automatically stored for subsequent recall at the next power on.



## 4 Installation

## INTRODUCTION

**OPERATING ENVIRONMENT** The oscilloscope will operate to its specifications if the environment is maintained within the following parameters:

Temperature 5° to 40° C (41° to 104° F)

Humidity <80%

**POWER REQUIREMENTS** The oscilloscope operates from a 115 V (90 to 132 V) or 220 V (180 to 250 V) normal power source at 45 Hz to 66 Hz. No voltage selection is required since the instrument automatically adapts to the line voltage which is present.

The instrument operates at line frequencies up to 440 Hz. However, the leakage current from phase to ground slightly exceeds the safety recommendations for industrial instruments in some countries. This current reaches 4 mA max. at 250 V/400 Hz.

The power supply of the oscilloscope is protected against short circuits and overload by means of two 5A/250 V fuses. The fuses are located above the mains plug.

Remove the power cable before changing or inspecting a fuse. Open the fuse box by inserting a small screwdriver under the plastic cover and prying it open.

### SAFETY INFORMATION

The oscilloscope has been designed to operate from a single-phase power source with one of the current-carrying conductors (neutral conductor) at ground (earth) potential. However, operation from power sources in which both current-carrying conductors are live with respect to ground (such as phase-to-phase on a tri-phase system) is also possible, as the oscilloscope is equipped with over-current protection for both mains conductors. None of the current-carrying conductors may exceed 250 V RMS with respect to ground potential. The oscilloscope is provided with a three-wire electrical cord containing a three-terminal polarized plug for mains voltage and safety ground connection. The plug's ground terminal is connected directly to the frame of the unit. For adequate protection against electrical hazard, this plug must be inserted into a mating outlet containing a safety ground contact.

The oscilloscope has not been designed to make direct measurements on the human body. Users who connect a LeCroy oscilloscope directly to a person do so at their own risk.

**INTRODUCTION**

---

**POWER ON**

Connect the oscilloscope to the power outlet and switch it on by pressing the power switch located on the rear panel. After the instrument is switched on, auto-calibration is performed and a test of the oscilloscope's ADCs and memories is carried out. The full testing procedure takes approximately 10 seconds, after which time a display will appear on the screen.

## 5 Front-panel Overview

### INTRODUCTION

See front-panel foldout at the beginning of the manual.

TIMEBASE & TRIGGER CONTROLS allow direct adjustment of Time/Div, Trigger Level and Trigger Delay. The AUTOSETUP button automatically adjusts the oscilloscope to acquire and display signals on the input channels.

CHANNEL CONTROLS allow direct adjustment of vertical sensitivity and offset. The FIND button automatically adjusts the sensitivity and offset to match the input signal.

The MEMORY CARD READER allows fast and convenient storage of waveforms and instrument setups.

ZOOM & MATH CONTROLS allow you to move, define and expand a trace. (The SELECTABCD button is used to select a trace).

MENU BUTTON & KNOBS allow easy control of the most sophisticated tasks.

CHANNEL INPUTS have selectable input impedance of  $50\ \Omega$  or  $1M\ \Omega$  over the entire sensitivity range.

DISPLAY. High-resolution 9-inch screen.

## 6 Control of the Oscilloscope

### INTRODUCTION

Many of the most commonly used controls can be directly accessed using the labelled pushbuttons and rotary knobs on the front panel. Activating these controls usually causes an immediate visible action. The eleven dark-grey buttons, together with the SHOW STATUS buttons, all give access to menus which have similar behavior. These are the MENU ENTRY keys. They turn on menus on the right-hand side of the display. These menus allow further control of the acquisition, processing, and display modes of the instrument. The SHOW STATUS button gives access to a series of displays summarizing the status of the acquisition, the instrument, and the waveforms.

#### ACTIVE BUTTONS

Menu buttons which are active have boxes drawn around their accompanying texts on the screen. Other texts are for information only and the corresponding buttons are not used. There are seven menu buttons. The lower two buttons also have associated knobs.

#### SWITCHING BETWEEN MENUS

Any time a MENU ENTRY key is pressed, the instrument immediately displays the desired configuration. This menu becomes the new primary menu.

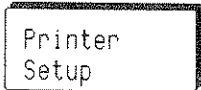

Printer  
Setup

Some of these primary menus have secondary menus under them. The heavy outline of the box associated with the button shows that there is a hidden menu behind it. Pushing the button will cause the appropriate secondary menu to be shown.

Whenever the RETURN button is pressed, the previous primary menu is shown. If the current menu is a primary menu then the menu will be switched off.

When the oscilloscope is put under remote control, the REMOTE ENABLE menu will be shown. It will contain a button "GO TO LOCAL" if this action is allowed. This is the only manual way to turn the REMOTE ENABLE menu off.

#### PERFORMING ACTIONS

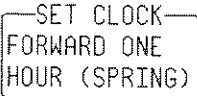

SET CLOCK  
FORWARD ONE  
HOUR (SPRING)

While most menu buttons modify a selected variable, some perform specific actions. In this case, the text which accompanies the button is written in all capital letters.

In most cases, the effect of changing a value in a menu causes the appearance of the screen to change because the new value is immediately used to change the acquisition settings or the processing, or for the display to be shown.

**INTRODUCTION**

**SETTING MENU OPTIONS**

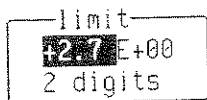
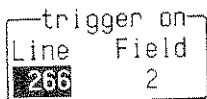
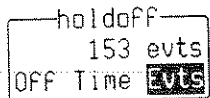
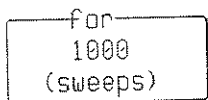
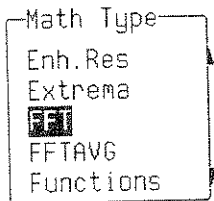
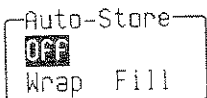

**GENERAL INSTRUMENT  
RESET**

Many options are controllable via the menu buttons and knobs. When setting up a new configuration the buttons should be adjusted, starting at the top to allow for the fact that the menu control for one primary option may be different from that of another primary option.

Some "single" buttons have one highlighted field among several in their associated texts. Pressing the button advances the highlighted field. If there is a knob associated with the button, it can also be used to navigate among the choices. If only one choice is shown, the button will not do anything.

There are also "double" buttons with one highlighted field. In this case, pressing the lower button causes the highlight to go forward among the choices whereas pressing the upper button causes the highlight to go backward. The arrow at the side of the button's text shows how the highlight will move. The arrow is missing if the highlight is at the beginning or end of the list of allowed values.

Some button and knob combinations control the value of a continuously adjustable variable. The knob is used to set the value of the variable, while the button may be used to either choose a highlighted field or make a simple change of the value of the variable.

Other button and knob combinations control the value of several continuously adjustable variables. The knob is used to set the value of the variable which is highlighted, while the button is used to choose which variable is to be highlighted.

To reset the instrument, simultaneously press the AUTO SETUP button, the top menu-button, and the RETURN button. The instrument will revert to its default power-up settings.

## 7 Display Overview

DISPLAY

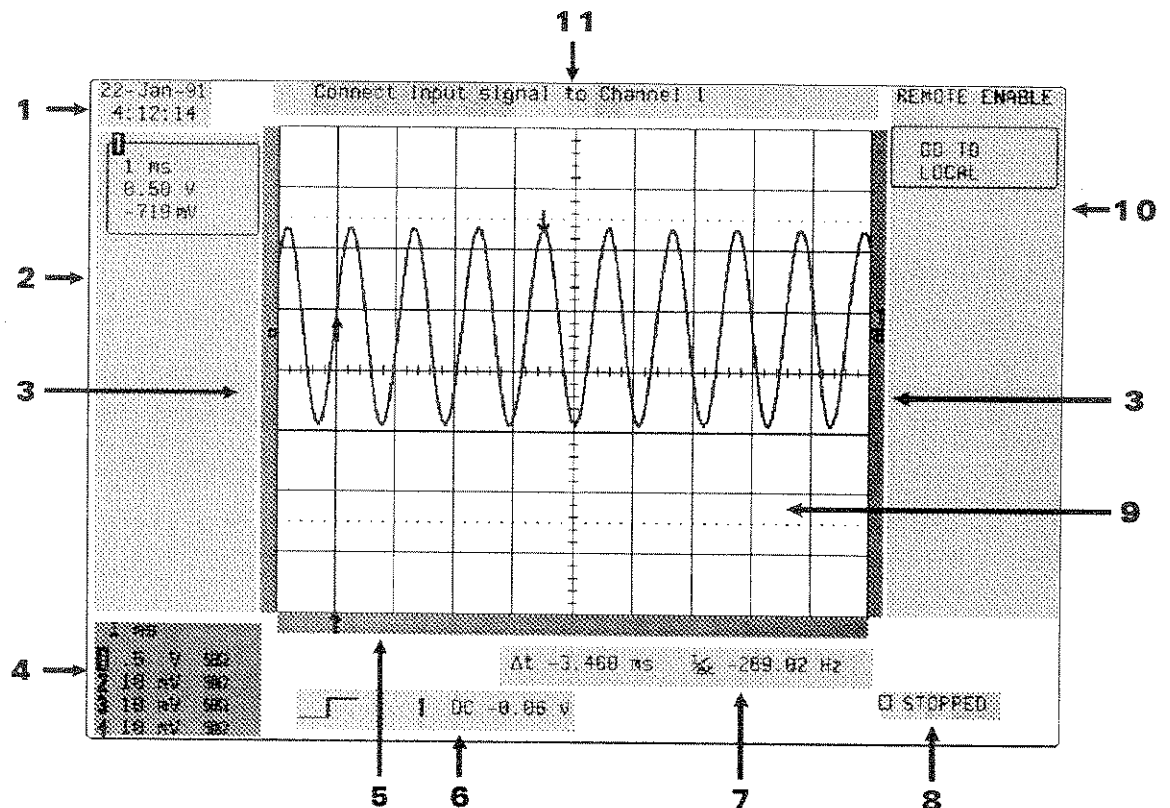

### REAL-TIME CLOCK FIELD (1)

Displays the current date and time provided by a battery-backed real-time clock.

### DISPLAYED TRACE FIELD (2)

Contains the identity of the displayed trace, its timebase and Volts/div settings, and cursor readings when applicable. Up to four traces can be shown simultaneously.

### TRIGGER LEVEL FIELD (3)

Contains the trigger level indicator on both sides of the grid, and the ground indicator for each channel on the right side of the grid.

### ACQUISITION SUMMARY FIELD (4)

Contains the common timebase setting and, for each channel, the vertical gain, probe attenuation and coupling. For 4-channel instruments, the currently selected channel is highlighted.

## DISPLAY

*Note: The displayed trace field shows the acquisition parameters that were set when the trace was captured or processed, whereas the acquisition summary indicates the present setting.*

### TRIGGER DELAY FIELD (5)

Indicates the trigger delay (arrow symbol) with respect to the left-hand edge of the grid. The delay can be adjusted from 0 to 10 divisions (pre-trigger) or from 0 to -10000 screen divisions (post-trigger). Pre-trigger delay appears as an upward arrow at the appropriate position in the field. Post-trigger is given as a delay in seconds.

When the relative-time cursors (two arrow cursors) are active (selected in MEASURE menu), this field displays the time interval between the two cursors. It also displays the frequency corresponding to  $1/(\text{time interval})$ .

### TRIGGER CONFIGURATION FIELD (6)

Displays the trigger source, slope, level and coupling. When applicable, additional information is given (hold-off by time or by number of events, logic states, etc...). A simple icon gives an overview of the trigger conditions.

### TIME AND FREQUENCY FIELD (7)

When the absolute-time cursor (cross-hair cursor) is active (selected in MEASURE menu), this field displays the time between the cursor and the trigger point.

### TRIGGER STATUS FIELD (8)

Indicates the trigger re-arming status (AUTO, NORMAL, SINGLE, STOPPED).

During an acquisition the little box at the left of the re-arming status will indicate when an intermediate acquisition occurs. This feature helps to monitor the trigger rate before the waveform is reconstructed.

For NORMAL status, a message SLOW TRIGGER may appear in the field when needed.

For slow acquisition, a message SLOW UPDATE appears, reminding the user that it will take a while before a new waveform will finish.

The region just to the left of the trigger status field can contain messages showing that lengthy processes, such as FFT calculations on screen dumps, are under way.



**DISPLAY**

**GRID (9)**

Displays traces from the acquisition or reference memories. A dual- or quad-grid presentation can also be selected in the display menu (see Chapter 18).

**MENU FIELD (10)**

This field is divided into seven sub-fields with menu buttons and two rotary knobs. Each field can display the name of a menu or perform an operation when the associated menu button is pressed. The RETURN button is used to restore the next higher menu level.

**MESSAGE FIELD (11)**

This field is used to display a variety of messages (warnings, indications, titles, etc...) that explain the instrument's current status.



## 8 Timebase + Trigger Capabilities

## TIMEBASE + TRIGGER

### TIMEBASE CAPABILITIES

Depending on the timebase setting, the following three sampling modes are possible:

- Single Shot
- Random Interleaved Sampling
- Roll Mode

For all timebases for which the single shot mode or roll mode can be used, the acquisition memory can be subdivided into user-defined segments to give:

- Sequence Mode

### SINGLE SHOT

Single Shot acquisition is the basic acquisition technique of a digital oscilloscope. Other timebase modes of the oscilloscope make use of this single shot acquisition technique.

An acquired waveform consists of a series of measured voltage values sampled at a uniform rate on the input signal. The acquisition is typically stopped at a fixed time after the arrival of a trigger event as determined by the trigger delay. The acquisition consists of a single series of measured data values associated with one trigger event. The time of the trigger event is measured using the timebase clock. The horizontal position of a waveform is determined using the trigger event as the definition of time 0. Waveform display is also done with this definition. Since each channel has its own ADC, the voltage on each of the input channels is sampled and measured at the same instant. This allows very reliable time measurements between different channels.

Trigger delay can be selected anywhere in a range that allows the waveform to be sampled from well before the trigger event up to the moment it occurs (100% pretrigger), or at a time starting at the equivalent of 10000 divisions (at the current Time/div) after the trigger.

For fast timebase settings the maximum single shot sampling rate of the ADC's is used. This is 500 Megasamples per second<sup>1</sup>. As the timebase setting is increased, more and more data samples are used to fill the waveform until the maximum memory size of the waveform has been reached. For timebases slower than this, the sampling rate is decreased while maintaining the number of data

<sup>1</sup> On one channel. Higher sampling rates can be achieved by combining channels. See Appendix A.

## TIMEBASE + TRIGGER

samples in the waveform. Single shot acquisition is allowed for all timebase ranges slower than 10 ns/div.

### Peak Detect

When using slow timebases, sample rate decreases as mentioned above, and very short events like glitches can be missed if they occur between two samples. To prevent this, a special circuitry – the peak detect system – can be switched on, capturing the signal envelope with a resolution of 2.5 ns, without destroying the underlying data which is captured simultaneously and on which processing (pulse parameters, FFT, averaging) can be performed.

### RANDOM INTERLEAVED SAMPLING

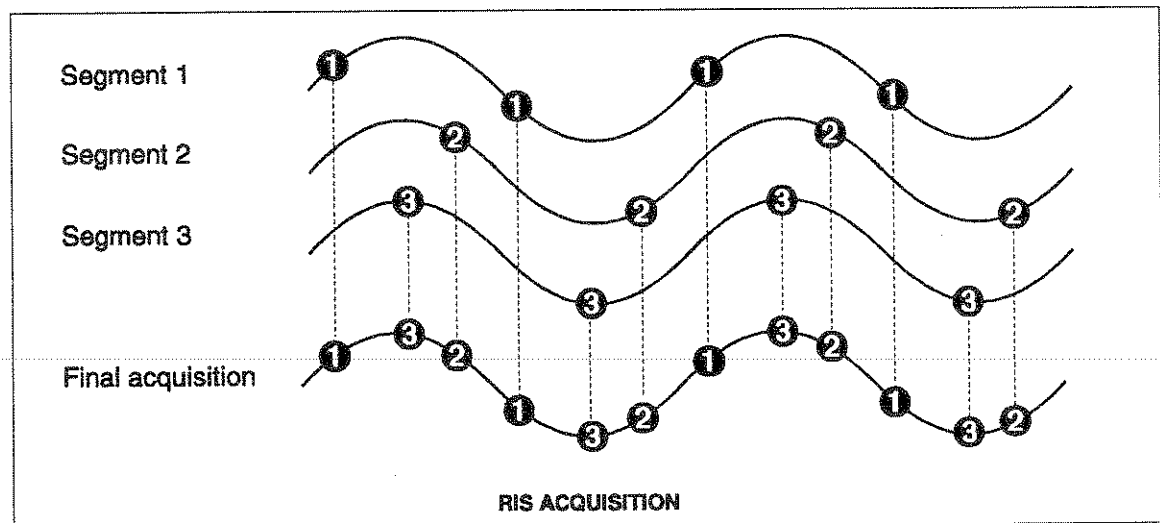

Random Interleaved Sampling (RIS) is an acquisition technique that allows effective sampling rates higher than the maximum single shot sampling rate (500 MS/s)<sup>2</sup>, and is used on repetitive waveforms with a stable trigger.

The maximum effective sampling rate of 10 GS/s can be achieved by acquiring 20 single shot acquisitions at 500 MHz, with each single shot segment starting approximately 0.1 ns later than the previous

<sup>2</sup> On one channel. Higher sampling rates can be achieved by combining channels. See Appendix A.

one. The process of acquiring 100 segments that satisfy this time constraint is random. The relative time between ADC sampling instants and the event trigger provides the necessary variation. It is measured by the timebase to 15 ps (RMS) accuracy.

Typically, 104 trigger events may be needed to complete an acquisition, although sometimes many more are needed. These segments are interleaved to provide a waveform that covers a time interval that is a multiple of the maximum single shot sampling rate. However, the real time interval over which the data for the waveform has been collected is orders of magnitude longer and depends on the trigger rate and the level of interleaving desired. The oscilloscope is capable of acquiring approximately 10000 RIS segments per second.

RIS acquisitions are allowed for timebase settings from 1 ns/div up to the point at which a 1 GS/s (1 ns/point) acquisition fills the available memory. At slower timebase settings there is no need to use the RIS technique.

RIS acquisitions do not have to be "complete" in order to be useful. A RIS acquisition can be stopped manually (STOP) or automatically (AUTO). The oscilloscope can treat RIS waveforms with missing segments.

#### ROLL MODE

Single shot acquisitions at timebase settings slower than 0.5 s/div (10 s/div for 2M records) have a sufficiently low data rate to allow the display of the incoming waveform in real time. The oscilloscope shows the incoming data continuously until a trigger event is detected and the acquisition is completed. The latest data is used to update a trace display that moves from right to left, similar to the output of a strip chart recorder.

Waveform MATH and Parameter calculations are done on the completed waveforms. The behavior of the STOP, SNGL, NORM, and AUTO buttons is modified when a roll mode acquisition is being used (see Chapter 9).

#### SEQUENCE MODE

Sequence mode is an alternative to single shot acquisition, and provides many unique features. The complete waveform consists of a selectable number of fixed-size segments acquired in a single shot mode (see Appendix A for the limits). The dead time between the trigger events for consecutive segments can be kept to 100  $\mu$ s as opposed to the hundreds of milliseconds usually required between consecutive single shot waveforms. Complicated sequences of events covering a large time interval can be captured with fine

## TIMEBASE + TRIGGER

details if there are uninteresting periods between the events. Time measurements can be made between events on different segments of a sequence waveform using the full precision of the acquisition timebase. Trigger time stamps are given for each of the segments in the TEXT & TIMES Status menu. Each individual segment can be displayed using the ZOOM capability or be used as input to the MATH package. For remote operation, sequence mode can be used to take full advantage of the high data transmission capability of the oscilloscope by overlapping the transmission of one waveform with the acquisition of its successor.

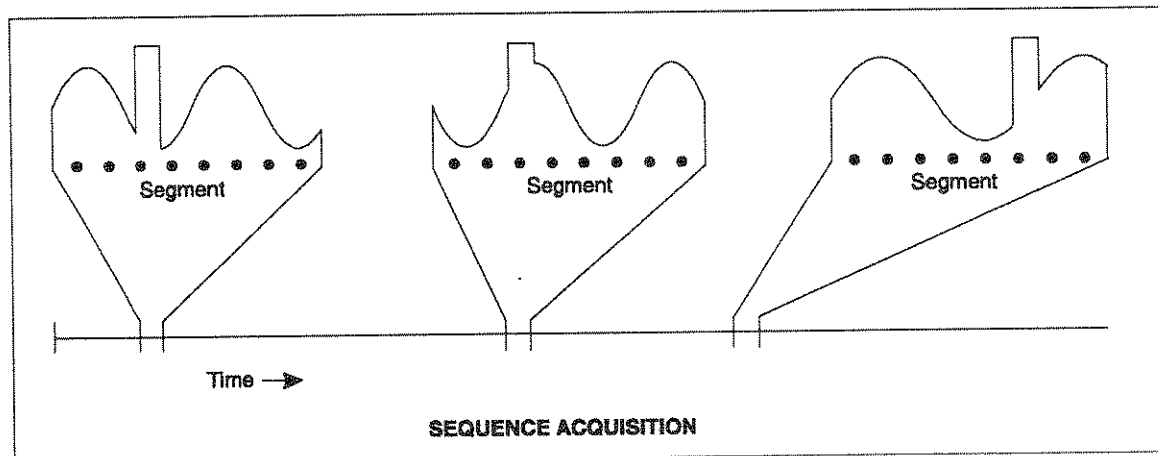

In sequence mode the timebase setting is used to determine the acquisition duration of each segment, which will be  $10 \times \text{TIME/DIV}$ . The timebase setting, the desired number of segments, the maximum segment length and the total memory available for the oscilloscope model are used to determine the actual number of samples/segment and time/point to be used. The display of the complete waveform with all of its segments may not entirely fill the screen.

Sequence mode is normally used to acquire the desired number of segments and terminate the waveform acquisition. It can also be used to acquire the segments continuously, overwriting the oldest ones as necessary. Then a manual STOP order or a timeout condition can be used to terminate the waveform acquisition. The behavior of the STOP, SNGL, NORM, and AUTO buttons is modified when a sequence mode acquisition is being used (see Chapter 9). To ensure low dead time between segments, button-pushing and knob-turning must be avoided during acquisition of sequences.

**TRIGGER CAPABILITIES**

The oscilloscope trigger is used to determine when to stop sampling data. The trigger possibilities have been divided into two classes:

- **EDGE** – including:
  - simple threshold triggers on an input signal
  - LINE signal triggers
  - triggers with holdoff by time
  - triggers with holdoff by number of trigger events
- **SMART** – including triggers requiring one trigger signal:
  - GLITCH triggers on the pulse width of a trigger signal
  - INTERVAL triggers on the interval between trigger transitions
  - TV triggers for composite video signals
  - DROPOUT trigger for transitions that cease after a while
  - PATTERN trigger on a logical combination of the state of each channel  
and
  - Qualified triggers which trigger on one signal after a transition on another signal with possible additional requirements

To capture rare phenomena such as glitches or spikes, missing bits, or intermittent faults, an oscilloscope must be able to trigger on elusive events. The 9350 series of oscilloscopes offer a variety of sophisticated trigger modes. They are based on a counter which can be set by one signal and pre-set, to count a specified number of events of another signal (1 to  $10^9$ ), or alternatively to measure time intervals up to 20 s.

A discussion of each of the SMART triggers can be found in Chapter 11, together with instructions on how to set them up.

**EDGE TRIGGER**

Single Edge triggers are described by a source, coupling, slope, and level condition. These same parameters are used to build up the SMART triggers.

**Source** is selected from:

- CH1, CH2 (CH3, CH4): the acquisition channel signal conditioned for the overall voltage gain, coupling, and bandwidth as described in Chapters 12 and 13.

## TIMEBASE + TRIGGER

- **LINE:** the line voltage which powers the oscilloscope. It can be used to provide a stable display of signals synchronous with the power line. Coupling and level are not relevant for this selection.
- **EXT:** the signal applied to the TRIG BNC connector. It can be used to trigger the oscilloscope within a range of  $\pm 2$  V.
- **EXT/10:** the signal applied to the TRIG BNC connector. It can be used to trigger the oscilloscope within a range of  $\pm 20$  V.

**Coupling** refers to the type of signal coupling at the input of the trigger circuit. Note that the trigger coupling can be selected independently for each of the sources. The DROPOUT and Qualified triggers use these selections. Therefore, a change of trigger source may also result in a change of the trigger coupling shown. The coupling choices are:

- **HF:** HF is only available for Channel 4 in 4-channel models and Channel 2 in 2-channel models. It is used for triggering on high-frequency repetitive signals in excess of 300 MHz. Maximum trigger rates greater than 500 MHz are possible. HF triggering should be used only when needed. It will be automatically overridden and set to AC when it is incompatible with other characteristics of the trigger mode. This is the case for Window Triggers and the SMART triggers. Only one slope is available. It will be shown by the trigger symbol.
- **AC:** Signals are capacitively coupled; DC levels are rejected and frequencies below 50 Hz are attenuated.
- **LF REJ:** Signals are coupled via a capacitive high-pass filter network. DC is rejected and signal frequencies below 50 kHz are attenuated. The LF REJ trigger mode is used when stable triggering on medium to high frequency signals is desired.
- **HF REJ:** Signals are DC coupled to the trigger circuit and a low-pass filter network attenuates frequencies above 50 kHz. The HF REJ trigger mode is used to trigger on low frequencies.
- **DC:** All of the signal's frequency components are coupled to the trigger circuit. This coupling mode is used in the case of high-frequency bursts, or where the use of AC coupling would shift the effective trigger level.

**Slope** selects the direction of the trigger voltage transition to be used to generate a trigger event.

The selected slope is associated with a trigger source in the same way as the coupling.

**Level** defines the source voltage at which the trigger circuit will generate an event. The selected level is associated with a trigger source in the same way as the coupling. Note that the trigger level is specified in volts and is normally unchanged when the vertical gain or offset is modified.

The amplitude of trigger signals and the range of trigger levels are limited as follows:

- $\pm 5$  screen divisions with a channel as trigger source.
- $\pm 2$  V with EXT as trigger source.
- $\pm 20$  V with EXT/10 as trigger source.
- None with LINE as trigger source (zero crossing is used).

#### EDGE Trigger with Holdoff

Holdoff is an additional characteristic of the trigger circuitry. When the Holdoff is OFF, the time between successive trigger events is limited only by the input signal, the coupling, and the oscilloscope's bandwidth.

Sometimes a stable display of complex repetitive waveforms can be achieved by putting a condition on this time. This holdoff is expressed either as a time or an event count. The time is measured starting at one trigger event, and the next event arriving after this time is allowed to trigger the oscilloscope. The event count is the number of trigger events to be ignored after one trigger event until the next one to be allowed. The choice of which holdoff mode is to be used depends on the application. Often, either one can be used to obtain the same result.

It should be noted that the holdoff is started by potential triggers and not at the end of an acquisition. Potential triggers will be accepted if the oscilloscope is ready, but will be ignored if the instrument is still busy handling the previous trigger event. In fact, the holdoff ensures synchronization between successive real triggers.





## 9 Timebase + Trigger Direct Controls

### TIMEBASE + TRIGGER

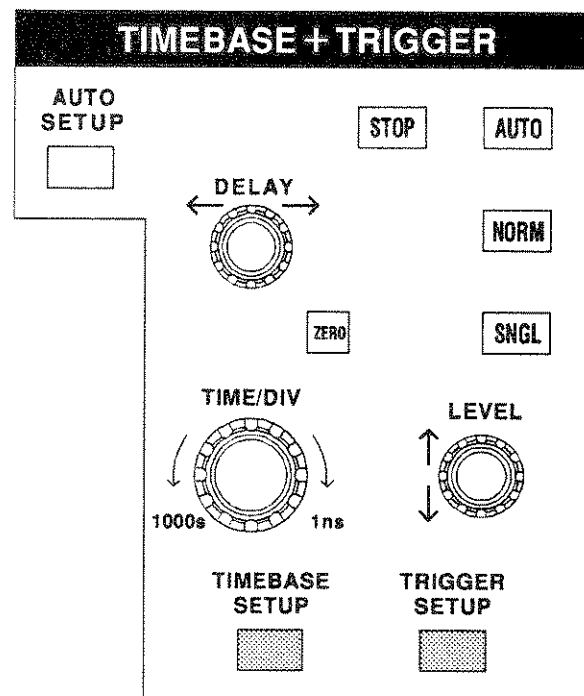

### STOP

This button is used to halt the acquisition and can be used in all three re-arming modes (AUTO, NORM, SNGL). Pressing the STOP button prevents the oscilloscope from acquiring a new signal.

If the STOP button is pressed while a single-shot acquisition is under way, the last acquired signal will be kept.

If a RIS acquisition has been started, it will be stopped and a partial waveform reconstruction will be performed.

If the acquisition is in the ROLL mode, it will be stopped and the incomplete acquisition data will be shown as if a trigger had occurred.

For Sequence acquisitions, the timebase will be stopped and all the new segments will be shown.

### AUTO

In AUTO mode, the oscilloscope automatically displays the signal if NO trigger occurs for more than 500 ms. If a trigger occurs within this time, the oscilloscope behaves as in NORMAL mode.

## TIMEBASE + TRIGGER

For the RIS mode, the acquisition will be terminated and shown each second, although some needed segments may be missing.

For the ROLL mode, the oscilloscope samples the input signals continuously and indefinitely. The acquisition has no trigger condition but can be stopped as desired by the user.

For Sequence mode, the acquisition will be terminated if the time between two consecutive triggers exceeds a selectable timeout (see the UTILITIES menu under SPECIAL MODES). The next acquisition is then started from segment 1.

### NORM

In this mode the screen is continuously updated as long as a valid trigger is present. If no valid trigger is present, the last signal is preserved and the warning "SLOW TRIGGER" is displayed in the Trigger Status Field.

For the ROLL mode, the acquisition is terminated when the last needed data after a trigger have been taken. The display is paused, showing the entire waveform. After a moment it will go back into the roll mode while it waits for the next trigger.

For the Sequence mode, the acquisition is terminated after the last segment is acquired. The next acquisition is started immediately. A Sequence WRAP mode in NORMal is the same as in SINGLE.

### SNGL

In Single Shot mode the instrument waits for one single trigger to occur, then displays the signal and stops acquiring. If no signal occurs, the button can be pressed again to show the signal being observed without a trigger.

When in RIS mode, (selected in TIMEBASE SETUP), the instrument will wait for all the trigger events required to build up ONE signal on screen before it stops (this may require as many as 4000 trigger events).

The ROLL mode is the same as single shot except that there is no need to push the button a second time to show the signal.

### AUTO SETUP

This button automatically scales the timebase, trigger level, offset, and Volts/div to provide a stable display of REPETITIVE signals.

Auto-setup rules:

- Auto Setup operates only on channels which are ON. If no channels are ON, then Auto Setup will operate on ALL the channels and will turn them all ON.

- Signals detected must have an amplitude between 2 mV and 40 V, a frequency greater than 50 Hz, and a duty cycle greater than 0.1%.
- If signals are detected on several channels, the channel with the lowest number will determine the selection of the timebase and trigger source.

**DELAY**

This knob is used to adjust the pre- or post-trigger delay.

Pre-trigger adjustment is available from 0 to 100% of the full time-scale, in steps of 1%. The pre-trigger delay is illustrated by the vertical arrow symbol on the bottom of the grid.

Post-trigger adjustment is available from 0 to 10000 divisions in 0.1 division increments. The post-trigger-delay value is labelled in seconds and is located in the Trigger Delay Field on the screen.

**ZERO**

Pressing this button causes the trigger delay to be set to zero, i.e. the trigger instant is the left-hand edge of the grid.

**TIME/DIV**

This knob selects the time per division in a 1-2-5 sequence. The time/div setting is displayed in the Acquisition Summary field.

**LEVEL**

This knob adjusts the trigger threshold.

The amplitude of trigger signals and the range of trigger levels is limited as follows:

- $\pm 5$  screen divisions with a channel as trigger source
- $\pm 2$  V with EXT as trigger source
- $\pm 20$  V with EXT/10 as trigger source
- Inactive with Line as trigger source

The trigger sensitivity is better than 1/3rd of a screen division.

**TIMEBASE SETUP**

This menu-entry key calls up the "TIMEBASE SETUP" menu described in chapter 10.

**TRIGGER SETUP**

This menu-entry key calls up the "TRIGGER SETUP" menu described in chapter 11.

11/11/2023

## 10 Timebase Setup

### TIMEBASE + TRIGGER

The Timebase Setup menu is used to select:

- Single-shot or Interleaved (RIS) acquisition
- External clock
- Channel pairing and Peak Detect
- Sequence mode
- The number of segments in sequence mode
- The maximum record length

The menu also shows the status of:

- The number of points acquired
- The sampling rate
- The total time span

TIMEBASE
T/div .1 $\mu$ s
500
samples at
500 Ms/s
( 2 ns/pt)
for 1 $\mu$ s
Sampling
<b>Single Shot</b>
RIS
Sample Clock
<b>Internal</b>
ECL 0V TTL
Channel Use
<b>4</b> 2
Peak-Detect
Sequence
<b>OFF</b> On Wrap
Record up to
50k
samples

#### Sampling

Two essential modes of operation may be selected with this menu button:

- **Single Shot** – the oscilloscope displays data collected during successive single-shot acquisitions from the input channels. This mode allows captures of **non-recurring** or **very low repetition-rate** events **simultaneously** on all the input channels.
- **RIS** – the oscilloscope uses a Random Interleaved Sampling technique to achieve a higher effective sampling rate than in single-shot mode, provided the input signal is repetitive and the trigger is stable.

#### Sample Clock

Selects the sample clock mode (internal or external). See page 10-5.

#### Channel Use

Selects channel pairing (see following page). Also controls the peak detect mode (see page 8-2).

#### Sequence

Selects Sequence mode (see page 10-3).

#### Record up to

Selects the maximum record lengths of the acquisition channels.

## TIMEBASE + TRIGGER

### MORE ON CHANNEL USE

Channels can be combined to achieve more memory and more sampling rate by interleaving the ADCs in time.

When channels are paired, Channel 1 and Channel 4<sup>1</sup> are disabled and the maximum sampling rate on Channel 2 and Channel 3<sup>1</sup> is 1 GS/s. The maximum record length is also doubled. On 4-channel units and on fast timebases it is possible to achieve 2 GS/s by means of a special adaptor (PP092) placed on Channel 2 and Channel 3. As soon as the PP092 is in place, the oscilloscope interleaves the four 500 MS/s ADCs and the acquisition memory to achieve a maximum sampling rate of 2 GS/s and up to four times the initial record length.

Channels used	Max. sample rate	Memory per channel			Notes
		9350/54	9350/54M	9350/54L	
All Peak Detect OFF	500 MS/s	25K	100K	2M	All channels active
All Peak Detect ON	100 MS/s data 400 MS/s peak	10K data + 10K peaks	50K data + 50K peaks	1M data + 1M peaks	All channels active 2.5 ns peak detect
Paired Peak Detect OFF	1 GS/s	50K	250K	4M	9350: CH1 9354: CH2 + CH3
Paired + PP092 Peak Detect OFF	2 GS/s	100K	500K	8M	9354 models only

<sup>1</sup> 4-channel units only

**SEQUENCE MODE****When Sequence is set to ON**

1. If the trigger mode is SINGLE, the oscilloscope fills the segments and stops, or if there are not enough trigger events to fill the segments, it waits forever unless the STOP trigger mode button is pressed.
2. If the trigger mode is NORM, the oscilloscope fills the segments and then, if more trigger events occur, the acquisition is restarted from segment 1.
3. If the trigger mode is AUTO, and if the time between two consecutive triggers exceeds a selectable time-out, the acquisition is restarted from segment 1.

The time-out can be selected in the UTILITIES menu under SPECIAL MODES (Chapter 19).

**When Sequence is set to WRAP**

The segments are filled continuously until the STOP trigger mode button is pressed. The last *n* segments will be displayed. An alternative way to stop the WRAP sequence is through AUTO mode: if the time between two consecutive triggers exceeds a selectable time-out, the acquisition will stop.

## TIMEBASE + TRIGGER

TIMEBASE
T/div 1 $\mu$ s
50 * 200
samples at
20 Ms/s
( 50 ns/pt)
for 10 $\mu$ s
Sampling
<b>Single Shot</b>
Sample Clock
<b>Internal</b>
ECL 0 v TTL
Sequence
50 segments
OFF <b>On</b> Wrap
Max. segment
2500
samples

### Sequence

The menu knob is used to select the desired number of segments.

### Max. segment

Selects via the menu knob/button the maximum record length for each segment.

*Note: A summary of the acquisition conditions is displayed at the top of the menu: number of segments, available record length per segment, sampling rate, and timebase setting.*



**EXTERNAL CLOCK**

Oscilloscopes fitted with the option CKIO allow the user to supply clock signals at the External TRIG BNC input which will be used to drive the ADCs of the instrument. Additional menu fields allow the choice of the type of external clock signal and the size of the record to be acquired.

TIMEBASE
EXTERNAL
10000
samples at
1000 s/div
Sampling
Single Shot
Sample Clock
Internal
ECL 0 v TTL
Sequence
Off On Wrap
Record
10K
samples

**Sampling**

This button is inactive when the external sample clock is being used. Only single-shot acquisition mode is available.

**Sample Clock**

Press this button to select the appropriate description of the signal applied to the TRIG BNC connector for use as the sample clock. The rising edge of the signal is used to clock the ADCs of the oscilloscope. The effective thresholds for sampling the input are:

- ECL - -1.3 V
- 0 V - 0.0 V
- TTL - +1.5 V

The risetime and falltime of the signal should both be less than 10 ms.

**Sequence**

This button is used to select Sequence Modes if desired. The knob is used to adjust the number of segments. Trigger time stamps are not available when the external clock is in use. The AUTO sequence timeout feature is not available. The intersegment dead time is no longer guaranteed.

**Record**

Use the knob to select the desired number of samples for the single-shot acquisition.

The time/div is now expressed in s/div which should be thought of as samples/div.

The trigger delay is also expressed in samples and can be adjusted as usual.

No attempt is made to measure the time difference between the trigger and the external clock. Therefore, successive acquisitions of the same signal can appear to jitter on the screen.

## TIMEBASE + TRIGGER

---

The oscilloscope will require a number of pulses (typically 50) before it recognizes the external clock signal. The acquisition is halted only when the trigger conditions have been satisfied and the appropriate number of data points have been accumulated.

Any adjustment to the time/division knob automatically returns the oscilloscope to normal (Internal) clock operation.

## 11 Trigger Setup

## TIMEBASE + TRIGGER

The Trigger Setup menu is used to select:

- The trigger mode
- The EDGE trigger settings
- SMART trigger settings that enable triggering on:
  - Glitches
  - Intervals
  - TV signals
  - State-qualified events
  - Dropouts
  - Patterns

### HOW THE TRIGGER MODES OVERLAP

Once specified, Trigger Level (i.e. threshold) and Trigger Coupling are the only parameters that are passed unchanged from mode to mode – and this is done for each trigger source.

### CHOOSING THE TRIGGER MODE

The Trigger Setup menu can be displayed at any time by pushing the dark-grey menu-entry key marked TRIGGER SETUP.

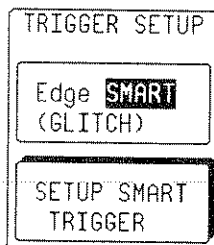

The top menu button allows the choice between EDGE and SMART triggers.

After activating the SMART trigger with the top menu button, all of the parameters for the current SMART trigger are shown for modification in the menu.

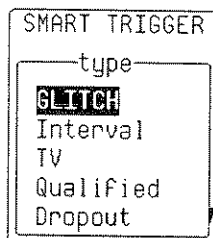

When SMART is selected, the SETUP SMART TRIGGER menu button gives access to a lower level menu where a different SMART trigger can be chosen. The top button in this menu gives the choice of SMART trigger types available.

**TIMEBASE + TRIGGER**

**EDGE TRIGGER**

- The EDGE mode is used to:
- Select a trigger source
  - Select the coupling for each source
  - Select the slope (positive or negative)
  - Define the holdoff in time or events

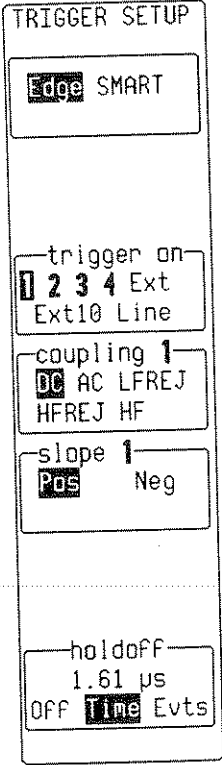

**Edge/SMART**

Activates either Edge trigger or SMART trigger mode.

**trigger on**

Selects the trigger source in Edge mode.

**coupling**

Selects the trigger coupling for the current source.

**slope**

Defines the trigger point to be on either the positive or negative slope of the selected source.

**holdoff**

Holdoff disables the oscilloscope's trigger circuit for a definable period of time or number of events after a trigger event occurs.

By pressing the holdoff menu button, holdoff can be defined as:

- a period of time
- a number of events (an event being a change in the input signal that satisfies the trigger conditions)

The menu knob is used to vary the "holdoff" value.

Time holdoff values in the range 10 ns – 20 s may be entered.

Event counts in the range 1 – 10<sup>9</sup> are allowed.

**EDGE Trigger Symbols**

Trigger Symbols are used to allow immediate recognition of the current trigger conditions. Examples of Edge trigger symbols are given in the following figure. The heavier transitions show where a trigger will be generated.

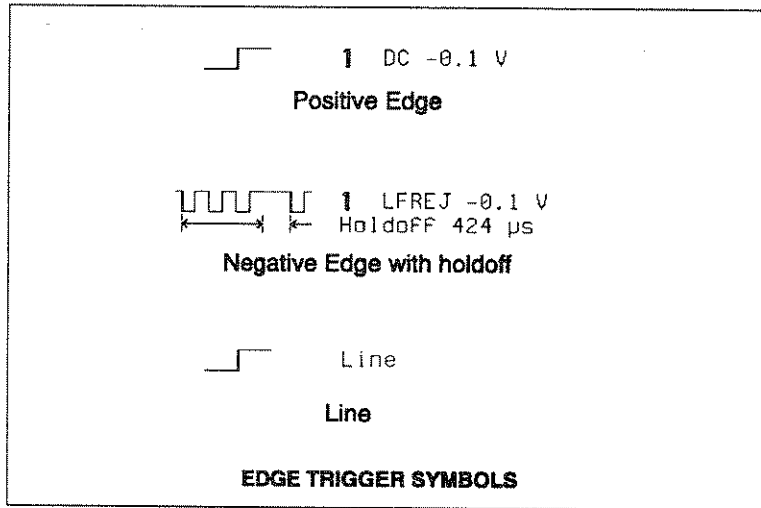

**TIMEBASE + TRIGGER**

**SMART TRIGGER**

TRIGGER SETUP
Edge <b>SMART</b> (GLITCH)
SETUP SMART TRIGGER
trigger on <b>1</b> 2 3 4 Ext Ext10
coupling 1 <b>DC</b> AC LFREJ HFREJ
at end of <b>Neg</b> Pos pulse
width < 7.5 ns OFF <b>On</b>
& width > 2.5 ns OFF <b>On</b>

The following describes the SMART trigger setup menu (called up by pressing the SETUP SMART TRIGGER menu button).

After activating the SMART trigger with the top menu button, all of the parameters for the current SMART trigger are shown for modification in the menu.

The SETUP SMART TRIGGER menu button gives access to a lower level menu where a different SMART trigger can be chosen. The top button in this menu gives the choice of SMART trigger types available (see following pages).

**GLITCH Trigger**

The GLITCH trigger tests the pulse width – at the trigger level – of the input signal. It is mainly used to trigger on glitches (fast transitions) that may occur in a signal under test.

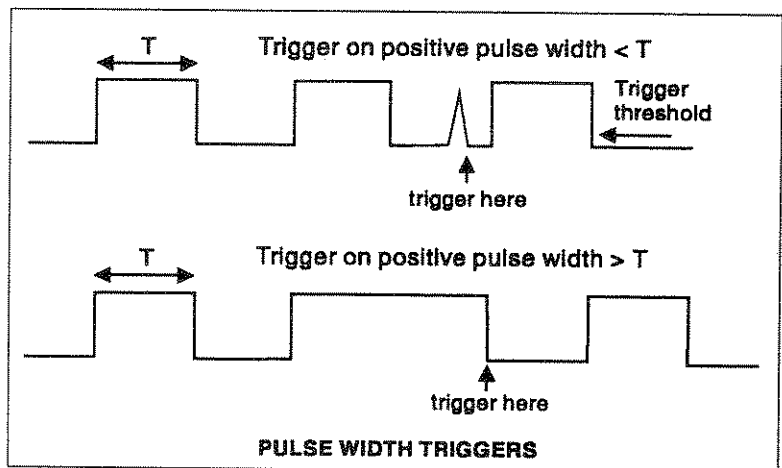

This trigger generates an event at the end of a pulse that satisfies the desired limits on its width. Both negative and positive pulses can be used. The width limits can be chosen as smaller or greater than a given value, within a time window, or outside a time window.

This feature offers a wide range of capabilities for application fields as diverse as digital and analog electronic development, ATE, EMI, telecommunications, and magnetic media studies. Catching elusive rare glitches becomes very easy. In digital electronics, where the circuit under test normally uses an internal clock, a glitch can be theoretically defined as any pulse with a width smaller than the clock period (or half period).

In a broader sense, a glitch can be defined as a pulse much faster than the waveform under observation.

Widths with 2.5 ns resolution starting at a minimum value of 2.5 ns can be selected. For recurrent glitches, the oscilloscope's random interleaved sampling mode allows glitch visualization with an equivalent sampling rate of up to 10 gigasamples/s, i.e. one sample point every 100 ps.

**TIMEBASE + TRIGGER**

SMART TRIGGER

type  
 GLITCH  
Interval  
TV  
Qualified  
Dropout

trigger on  
 1 2 3 4 Ext  
Ext10 Pattern

coupling 1  
 DC AC  
LFREJ HFREJ

at end of  
 Neg Pos  
pulse

width <  
12.5 ns  
OFF  On

& width >  
2.5 ns  
OFF  On

**type**  
Select **GLITCH** trigger.

**trigger on**  
Selects the source of the GLITCH trigger.

**coupling**  
Selects the coupling of the GLITCH trigger.

**at end of**  
Defines the test on either **positive** or **negative** pulses.

**width <**  
Trigger if the pulse is smaller than the value defined in that field. The value can be adjusted with the menu knob associated with the field. The test can be turned on or off by pressing the menu button, and can be used in combination with the **width >** test.

Width values in the range 2.5 ns to 20 s may be entered.

**& width >**  
Trigger if the pulse is greater than the value defined in that field. The value can be adjusted with the menu knob associated with the field. The test can be turned on or off by pressing the menu button, and can be used in combination with the **width <** test.

The two width limits are combined to select glitches within a window if the width < value is greater than the width > value. Otherwise, they are combined to select glitches outside of the window.



When "Pattern" is selected in GLITCH trigger type, the instrument triggers on the logic AND of up to four sources (up to two on 2-channel instruments). See also Pattern trigger, page 19.

SMART TRIGGER

type

**GLITCH**  
Interval  
TV  
Qualified  
Dropout

trigger on

**1 2 3 4** Ext  
Ext10 **Pattern**

for pattern

Present  
**Absent**

width <

12.5 ns  
OFF **On**

& width >

2.5 ns  
OFF **On**

**trigger on**

Select **Pattern**.

**for pattern**

Select pattern **Present** or **Absent**.

**width <**

Trigger if the pattern is present – or absent – for less than the time value defined in that field. The value can be adjusted with the menu knob associated with the field. The test can be commuted to **for >** by pressing the menu button.

**& width >**

Trigger if the pattern is present – or absent – for more than the time value defined in that field. The value can be adjusted with the menu knob associated with the field. The test can be commuted to **for <** by pressing the menu button.

**TIMEBASE + TRIGGER**

**Interval Trigger**

Similar to GLITCH trigger except that the test is performed over an interval width rather than over a pulse width. See figure below.

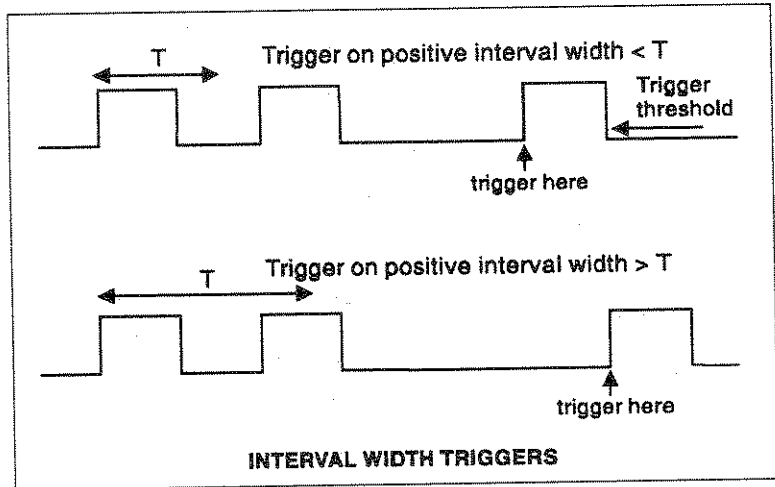

This trigger generates an event if the interval between two similar transitions of the trigger signal satisfies the desired limits. It is similar to the GLITCH trigger except that the lower time limit is 10 ns.

Missing bits in long data streams are easily triggered on using the interval-width triggering facility. For ranging applications, interval trigger may be used to ignore unwanted signal reflections.

SMART TRIGGER	
type	
GLITCH	<input type="checkbox"/>
<b>Interval</b>	<input checked="" type="checkbox"/>
TV	<input type="checkbox"/>
Qualified	<input type="checkbox"/>
Dropout	<input type="checkbox"/>
trigger on	
<input type="checkbox"/> 1	<input type="checkbox"/> 2
<input type="checkbox"/> 3	<input type="checkbox"/> 4
Ext	Ext10
Pattern	
coupling	
<b>DC</b>	AC
LFREJ	HFREJ
between	
<b>Pos</b>	Neg
edges	
interval <	
42.5 ns	<input type="checkbox"/>
OFF	<input checked="" type="checkbox"/>
OR interval >	
0.645 ns	<input type="checkbox"/>
OFF	<input checked="" type="checkbox"/>

**type**

Select Interval trigger.

**trigger on**

Selects the source of the Interval trigger.

**coupling**

Selects the coupling of the Interval trigger.

**between**

Defines the interval between two adjacent **positive** or **negative** edges.

**interval <**

Trigger if the interval is smaller than the value defined in that field. The value can be adjusted with the menu knob associated with the field. The test can be turned on or off by pressing the menu button, and can be used in combination with the **interval >** test.

Interval values in the range 10 ns to 20 s may be entered.

**OR interval >**

Trigger if the interval is greater than the value defined in that field. The value can be adjusted with the menu knob associated with the field. The test can be turned on or off by pressing the menu button, and can be used in combination with the **interval <** test.

The two interval limits are combined to select intervals within a window if the interval < value is greater than the interval > value. Otherwise, they are combined to select intervals outside of the window.

## TIMEBASE + TRIGGER

---

### TV Trigger

The TV trigger allows stable triggering on standard or user-defined composite video signals. The oscilloscope can trigger on a specific line of a given field.

This trigger is a special form of the Edge Qualified trigger. A composite video signal on the trigger input is analyzed to provide a signal for the beginning of the chosen field (any, odd, or even) and a signal at the beginning of each line. The field signal provides the starting transition and the beginning of line pulses are counted to allow the final trigger on the chosen line. The TV trigger includes an enhanced field counting capability which can maintain the trigger on a known field relative to some initial trigger (FIELDLOCK). The field, number of fields and the field rate, interlace factor, and number of lines/picture must be specified for this feature. Standard settings exist for the most popular forms of TV signals. The TV trigger can also function in a simple any line mode. Applications can be found wherever TV signals are present.

SMART TRIGGER	
type	
GLITCH	
Interval	
TV	
Qualified	
Dropout	
TV signal on	
1	2 3 4
Ext	Ext10
# of fields	
1	2
4	8
TV type	
Standard	
Custom	
as	
625/50/2:1	
525/60/2:1	
trigger on	
Line	Field
315	2

**type**

Select TV trigger.

**TV signal on**

Selects the source of the TV trigger.

**# of fields**

Defines the number of fields (up to 8).

**TV type**

Selects either standard or custom TV decoding.

**as**

When the TV type on the above field is set to standard, selects between 625/50/2:1 or 525/60/2:1 standard. When the TV type is set to custom, defines the number of lines, number of cycles, and interlacing factor for non-standard TV signals.

**trigger on**

Selects the line and field number the oscilloscope should trigger on.

## TIMEBASE + TRIGGER

### NOTES

- A. Most TV systems have more than two fields and the enhanced field-counting capability (FIELDLOCK) allows the oscilloscope to trigger consistently on a chosen line within a chosen field of the signal. It should be noted that the field numbering system is relative in that the oscilloscope cannot distinguish between lines 1, 3, 5, and 7 (or 2, 4, 6, and 8) in an absolute way.
- B. For each of the characteristics the following remarks apply:
- 1) 625/50/2:1 (European style PAL and SECAM systems)  
*This setting should be used for most of the standard 50 field/s signals. The lines may be selected in the range 1 to 626 where line 626 is identical to line 1.*  
*Number of fields = 8 should be very useful for color PAL signals. Number of fields = 4 is appropriate for SECAM signals.*
  - 2) 525/60/2:1 (American style NTSC systems)  
*This setting should be used for standard 60 field/s NTSC signals. The lines are selectable in the range 1 to 1051, where line 1051 is identical to line 1.*  
*Number of fields = 4 should be very useful for American-style NTSC systems.*
  - 3) ?/50/?, ?/60/?  
*In order to allow maximum flexibility, no line-counting convention is used. The line count should be thought of as a line-synchronizing pulse count, and it includes the transitions of the equalizing pulses. For certain extreme cases of TV signals, the field transition recognition will no longer work. In this case, only the "any line" mode will be available.*
- C. The enhanced field-counting capability cannot be used for RIS acquisitions.
- D. Composite video signals must have negative-going synch to be decoded correctly.

**Qualified Trigger**

In this mode a transition of one signal above or below a given level, the validation, serves as an enabling condition to a second signal which is the source of the trigger. The trigger can occur either immediately after the validation, within a time limit after the validation, or after a predetermined time delay or count of potential trigger events. It is important to note that the time delay or trigger count is restarted at every validation. For the Qualified by state mode of this trigger, the amplitude of the first signal must remain in the desired state until the trigger occurs. In the Qualified by Edge mode, the validation is sufficient and there is no additional requirement placed on the first signal.

Typical applications can be found wherever time violations may occur, for example in micro-processor debugging or telecommunications.

**Qualified By State Trigger**

In **State** mode, the qualifier signal is valid when it goes and stays above (or below) a defined threshold. A trigger is accepted – while the qualifier signal is valid – after a given time or after a given number of trigger events. When the qualifier signal ceases to be valid, the time- and event-counters are reset.

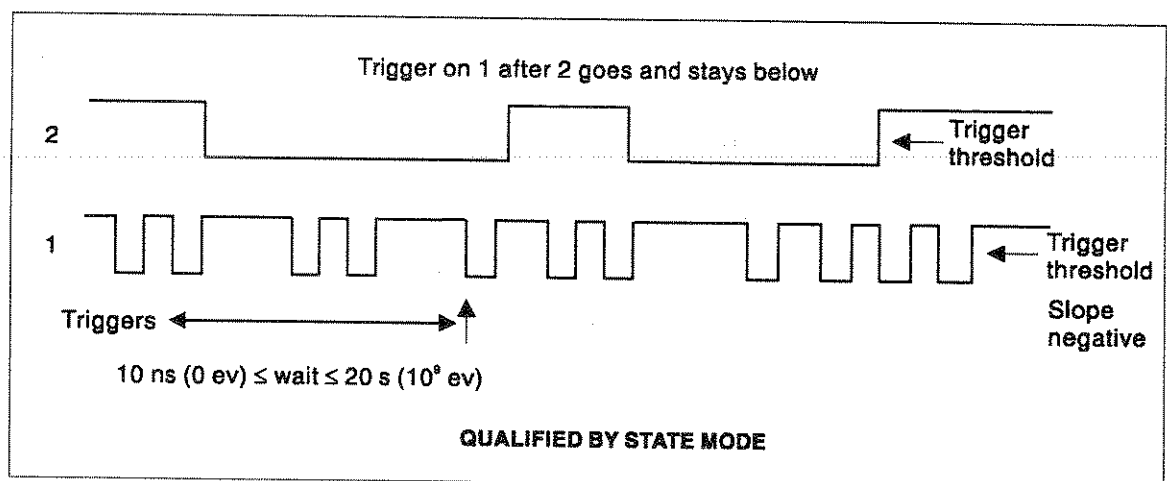

**TIMEBASE + TRIGGER**

SMART TRIGGER

type  
Interval  
TV  
**Qualified**  
Dropout  
Pattern

by  
Edge **State**  
(qualifier)

trigger on  
**1** 2 3 4  
Ext Ext10

only after  
1 **2** 3 4 Ext  
Ext10 Pattern

goes & stays  
**Above** Below  
1.80 V

wait  
60 ns  
OFF T< **T>** Evs

**type**

Select **Qualified** trigger.

**by**

Select **State**.

**trigger on**

Selects the trigger source. The other conditions for this source can be set up using an Edge trigger.

**only after**

Selects the qualifier source. The other conditions for this source can be set up using an Edge trigger.

**goes & stays**

The rotary knob adjusts the qualifier threshold and the pushbutton determines whether the qualifier signal is valid above or below that threshold. When "Pattern" is selected as the qualifier source, this field determines whether the pattern should be "present" or "absent". See also Pattern trigger, page 11-19.

**wait/within**

Specifies the time limit (T<) for accepting the trigger event. Alternatively, it specifies how much time (T>) or how many trigger events (Evs) should be allowed before the acquisition is taken on the next trigger event. The qualifier signal must remain valid until the final trigger has been received.

The time value can be chosen in the range 10 ns – 20 s.

The trigger event count can be chosen in the range 1 – 10<sup>9</sup>.



**Qualified By Edge Trigger**

In Edge mode, the qualifier signal is valid as soon as it has gone above (or below) a defined threshold (valid transition). A trigger is accepted within a time or after a given time or number of trigger events. However, as soon as a new valid transition occurs, the time- and event-counters are reset.

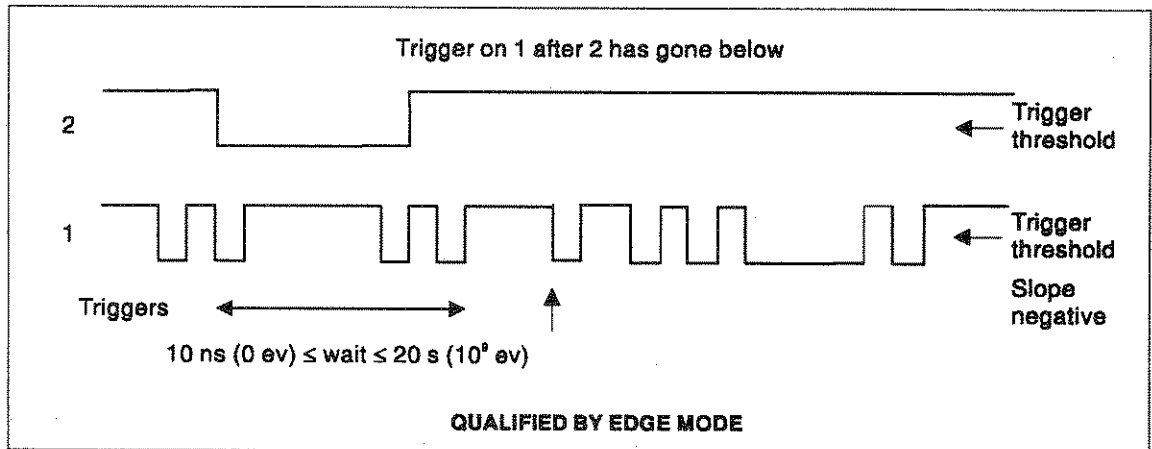

## TIMEBASE + TRIGGER

SMART TRIGGER	
type	
Interval	
TV	
<b>Qualified</b>	
Dropout	
Pattern	
by	
<b>Edge</b> State	
(qualifier)	
trigger on	
<b>1</b> 2 3 4	
Ext <b>EXT10</b>	
after	
<b>1</b> 2 3 4 Ext	
Ext10 Pattern	
has gone	
<b>Above</b> Below	
0.260 V	
within	
130 ns	
OFF <b>T&lt;</b> T> Evs	

### type

Select **Qualified** trigger.

### by

Select **Edge**.

### trigger on

Selects the trigger source. The other conditions for this source can be set up using an Edge trigger.

### after

Selects the qualifier source. The other conditions for this source can be set up using an Edge trigger.

### has gone

Adjusts the qualifier threshold and determines whether the qualifier signal is valid once it *has gone* above or below that threshold. When "Pattern" is selected as the qualifier source, this field determines whether the pattern should be "present" or "absent". See also Pattern trigger, page 11–19.

### wait/within

Specifies the time limit (T<) for accepting the trigger event. Alternatively, it specifies the delay in time (T>) or number of trigger events (Evs) after a valid transition has occurred. A trigger can only be accepted after this delay

*Note: Any subsequent qualifier event restarts this count.*

The time value can be chosen in the range 10 ns – 20 s.

The trigger event count can be chosen in the range 1 – 10<sup>9</sup>.

## Dropout Trigger

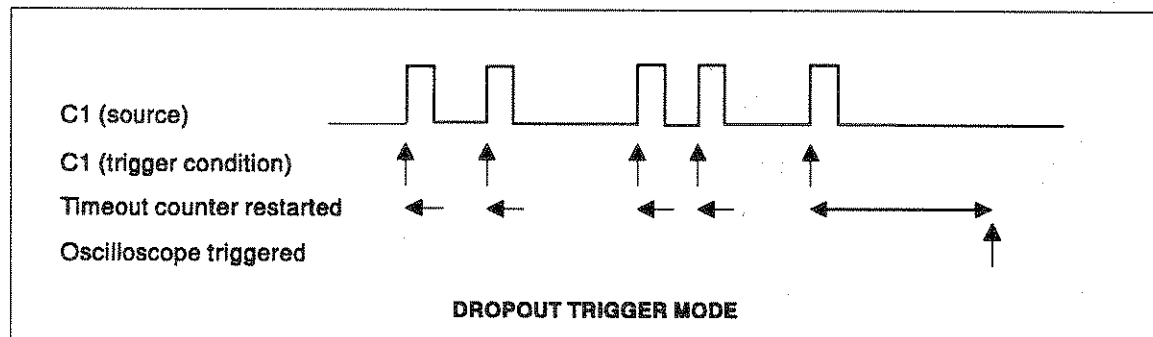

In this mode, a trigger is generated if edge-like signal transitions cease on the trigger source for the timeout value selected. The trigger event is generated at the end of the timeout period following the "last" trigger source transition.

A typical application is to look at the last "normal" interval of a signal that has disappeared completely. This is an essentially single-shot application, usually with a pre-trigger delay. A RIS acquisition does not make any sense since the timing of the trigger timeout is not sufficiently well correlated with the input channel signals.

## TIMEBASE + TRIGGER

SMART TRIGGER

type

Interval  
TV  
Qualified  
**Dropout**  
Pattern

Trigger after  
timeout, if  
NO edge

occurs on

1 2 3 4  
Ext **Ext10**

with slope

**Positive**  
Negative

within  
1.64  $\mu$ s  
(timeout)

of previous  
edge

### type

Select **Dropout** trigger.

### trigger after timeout, if NO edge occurs on

Selects the Dropout trigger source.

### with slope

Defines whether the measurement has to be made starting on a **Positive** or **Negative** slope of the trigger signal.

### within... of previous edge

Defines the time-out value in the range 25 ns – 20 s.

### Pattern Trigger

A pattern trigger is defined as a logical AND combination of the states of Channel 1, Channel 2, Channel 3, Channel 4 and EXT. The states are defined as being either low (L) or high (H) or don't care (X) with respect to the individually defined trigger thresholds. Furthermore, the user decides whether the oscilloscope should trigger at the beginning of the defined pattern or at the end, i.e. when the pattern is "entered" or "exited".

The pattern trigger will be appreciated every time complex logic has to be tested. Examples are: computer or microprocessor debugging; High Energy Physics where a physical event is identified by several events occurring simultaneously; and debugging of data transmission buses in telecommunications.

When set to pattern trigger, the oscilloscope always checks the logic AND of the defined input logic states. However, with the help of de Morgan's laws, the pattern becomes much more general. To demonstrate this, consider an example which is of particular importance, that is a *bi-level* or *window* trigger.

Bi-level trigger means that the user is expecting a single-shot signal where the amplitude will go outside a known range in either direction.

To set up a bi-level trigger the signal should be connected to two inputs, Channel 1 and Channel 2 (or any other pair of triggerable inputs). For example, the threshold of Channel 1 should be set to +100 mV and the threshold of Channel 2 to -200 mV. The required bi-level trigger will occur if the oscilloscope triggers on Channel 1 for any pulse greater than + 100 mV or on Channel 2 for any pulse more negative than -200 mV. For improved precision, the gains of the two channels should be at the same setting.

In Boolean notation we can write:

$$\text{Trigger} = \text{CH1} + \overline{\text{CH2}}$$

i.e. trigger when entering the pattern:

$$\text{CH1} = \text{high OR CH2} = \text{low}$$

By de Morgan's laws this is equivalent to:

$$\text{Trigger} = \overline{\overline{\text{CH1}} \cdot \text{CH2}}$$

i.e. trigger when exiting the pattern:

$$\text{CH1} = \text{low AND CH2} = \text{high}$$

## TIMEBASE + TRIGGER

This configuration can be programmed easily.

The possibility of setting the threshold individually for each channel extends this method to a more general window trigger where, in order to have a trigger it is required that the input pulse amplitude lies within or outside a given arbitrary window.

The pattern trigger has been designed to let the user choose the trigger point. By choosing LHX entering, the trigger will be given at the moment that the pattern LHX becomes true.

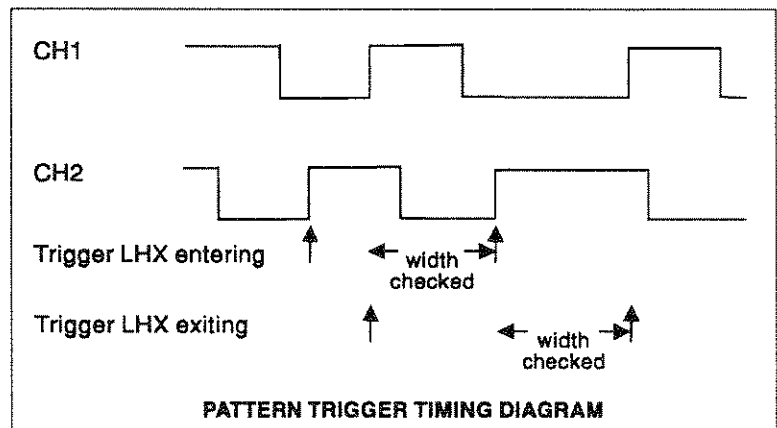

SMART TRIGGER	
type	
Interval	
TV	
Qualified	
Dropout	
<b>Pattern</b>	
trigger on	
Exiting	
<b>Entering</b>	
Pattern with	
<b>1</b> L 2 L 3 H	
4 H Ext L	
coupling 1	
<b>DC</b> AC	
LFREJ HFREJ	
level	
0.260 V	
<b>L</b> H X	
holdoff	
1.61 $\mu$ s	
OFF <b>Time</b> Evts	

**type**

Select **Pattern** trigger.

**trigger on**

Select **Entering** if the oscilloscope ought to trigger when the pattern starts to be "true", or **Exiting** if it ought to trigger when the pattern stops being "true".

**Pattern with**

Select the channel to be modified, then change settings in lower menu boxes.

**coupling**

Select coupling desired.

*Note: HF coupling is not available for Pattern trigger.*

**level**

Use the knob to adjust the level, and the button to choose between L (Low), H (High), or X (Don't care).

**holdoff**

Holdoff disables the oscilloscope's trigger circuit for a definable period of time or number of events *after* a trigger event occurs.

By pressing the holdoff menu button, holdoff can be defined as:

- a period of time
- a number of events (an event being a change in the input signals that satisfies the trigger conditions)

The menu knob is used to vary the "holdoff" value.

Time holdoff values in the range 50 ns – 2.0 s are allowed.

Event counts in the range 1 – 10<sup>9</sup> are allowed.

**TIMEBASE + TRIGGER**

**SMART Trigger Symbols**

Trigger Symbols are used to allow immediate recognition of the current trigger conditions. Examples of SMART trigger symbols are given in the following figure. The heavier transitions show where a trigger will be generated.

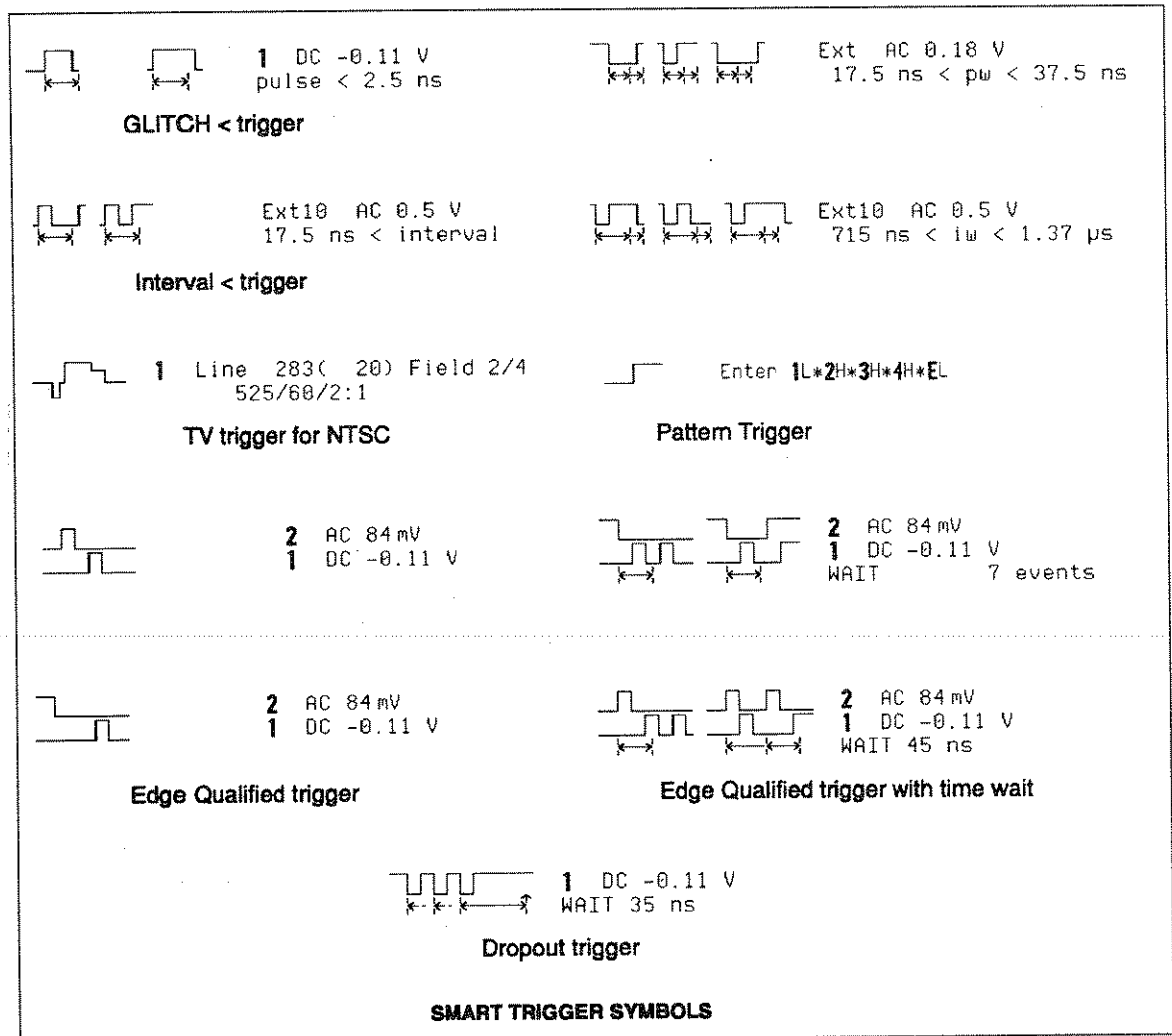

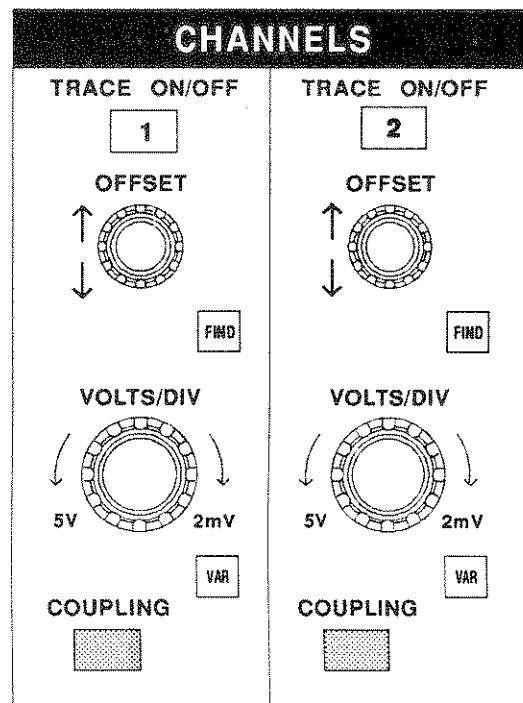

## 2-channel oscilloscopes

**TRACE ON/OFF**

Pressing a TRACE ON/OFF button causes the corresponding channel trace to be displayed or to be switched off.

**OFFSET**

This knob vertically positions the channel.

**FIND**

This button automatically adjusts the offset and the volts/div to match the input signal in the channel.

**VOLTS/DIV**

Selects the vertical sensitivity factor in a 1–2–5 sequence, or continuously (see VAR). The effect of gain changes on the acquisition offset can be chosen as described in the SPECIAL MODES menu (Chapter 19).

## CHANNELS

---

### VAR

This button allows the user to choose whether the VOLTS/DIV knob modifies the vertical sensitivity in a continuous manner or in discrete 1-2-5 steps.

The format of the vertical sensitivity in the acquisition summary field (bottom left of the screen) shows whether the VOLTS/DIV knob is operating in the "continuous" or "stepping" mode.

### COUPLING

This button calls up the COUPLING menu described in Chapter 13.

## 4-channel oscilloscopes

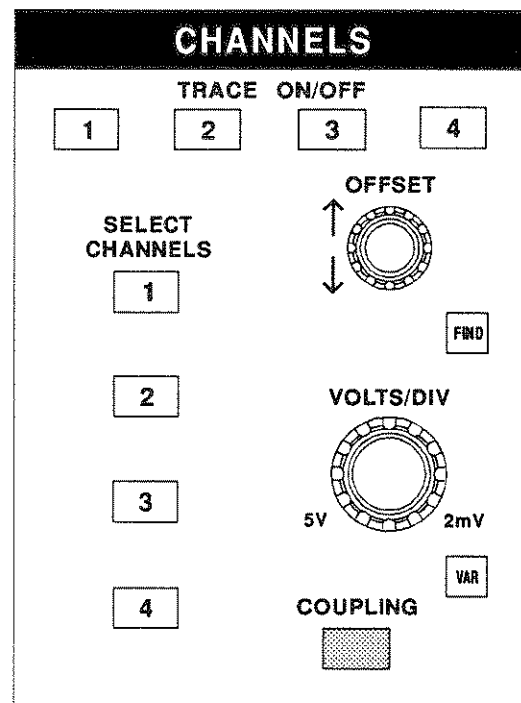
**TRACE ON/OFF**

Pressing a TRACE ON/OFF button causes the corresponding channel trace (1, 2, 3 or 4) to be displayed or to be switched off. The OFFSET and VOLTS/DIV controls will then be attributed to this channel, which will be referred to as the active channel.

**SELECT CHANNEL**

The SELECT CHANNEL buttons cause the corresponding channel to become active (i.e. all the vertical controls will be attributed to it). This control is independent of whether the channel is displayed or not.

**OFFSET**

This knob vertically positions the active channel.

**FIND**

This button automatically adjusts the offset and the volts/div to match the input signal in the active channel.

## CHANNELS

---

### **VOLTS/DIV**

Selects the vertical sensitivity factor in a 1–2–5 sequence, or continuously (see VAR). The effect of gain changes on the acquisition offset can be chosen as described in the SPECIAL MODES menu (Chapter 19).

### **VAR**

This button allows the user to select whether the VOLTS/DIV knob modifies the vertical sensitivity in a continuous manner or in discrete 1–2–5 steps.

The format of the vertical sensitivity in the acquisition summary field (bottom left of the screen) shows whether the VOLTS/DIV knob is operating in the "continuous" or "stepping" mode.

### **COUPLING**

This button calls up the COUPLING menu described in Chapter 13.

## 13 Coupling

## CHANNELS

The Coupling menu is used to select:

- The coupling and grounding of each input channel
- ECL or TTL gain, offset and coupling preset for the channel shown
- The probe attenuation of each input channel
- The bandwidth limiter for all of the channels

*Note: On 4-channel models the SELECT CHANNEL buttons on the front panel allow the selection of the channel number in the COUPLING menu. On 2-channel models, a dedicated COUPLING menu button is available for each channel.*

CHANNEL 1

Coupling

**DC50Ω**  
Grounded  
DC1MΩ  
Grounded  
AC1MΩ

V/div Offset

**NORMAL**  
ECL TTL

Global BWL

**OFF** On  
( 30 MHz)

Probe Atten

x2  
x5  
**x10**  
x20  
x25

### Coupling

Selects the coupling of the input channel. If an OVERLOAD condition is detected on a channel, the instrument will automatically set this channel to the grounded state. The button will then show OVERLOAD.

### V/div Offset

If NORMAL is highlighted, pushing the button once sets the offset, Volts/div, and input coupling to properly display ECL signals. Pushing the button a second time gives the settings for TTL signals. Pushing the button once more returns the settings to those used at the last manual setup of the channel.

### Global BWL

Sets the bandwidth limit OFF or ON

The bandwidth can be reduced from 300 MHz to 30 MHz (-3dB). Bandwidth limiting may be useful in reducing signal and system noise or preventing high-frequency aliasing. For example, bandwidth limiting reduces any high-frequency signals that may cause aliasing in single-shot applications.

*Note: This command is global and affects all the input channels.*

### Probe Atten

Sets the probe attenuation factor related to the input channel.

## CHANNELS

### ProBus System

The ProBus™ system provides a complete measurement solution from probe tip to oscilloscope display, automatically sensing the probe attenuation. Vertical gain, offset and coupling are all automatically handled via the usual front-panel controls so that the probing system is totally integrated to the instrument – and transparent to the operator. In addition, each probe has an offset and gain correction table that is automatically read by ProBus and taken into account in the oscilloscope.

This menu shows the settings available for AP020 × 10 active probe.

CHANNEL 1	
Coupling	
<input checked="" type="checkbox"/>	DC1MΩ
<input type="checkbox"/>	Grounded
<input type="checkbox"/>	AC1MΩ
V/div Offset	
<input checked="" type="checkbox"/>	NORMAL
<input type="checkbox"/>	ECL
<input type="checkbox"/>	TTL
Global BWL	
<input checked="" type="checkbox"/>	Off
<input type="checkbox"/>	On
( 30 MHz)	
Probe sensed	
(AP020)	
x10	

**MORE ON COUPLING**

In the AC position, signals are coupled capacitively, thus blocking the input signal's DC component and limiting the signal frequencies below 10 Hz.

In the DC position, all signal frequency components are allowed to pass through, and  $1\text{ M}\Omega$  or  $50\ \Omega$  may be chosen as the input impedance. It should be noted that with  $1\text{ M}\Omega$  input impedance the bandwidth is limited to approximately 250 MHz.

The maximum dissipation into  $50\ \Omega$  is  $0.5\text{ W}$  and inputs will automatically be disconnected whenever this occurs. An indication of the overload can be found in the Acquisition Summary Field and in this menu. The overload condition is reset by removing the signal from the input and selecting the  $50\ \Omega$  input impedance again.

**PROBES**

Model PP002 passive probes are supplied with the oscilloscope. These probes have  $10\text{ M}\Omega$  input impedance and  $16\text{ pF}$  capacitance. The system bandwidth with these probes is DC to 250 MHz (typical) in  $1\text{ M}\Omega$  DC coupling, and  $>10\text{ Hz}$  to 250 MHz in AC coupling.

To calibrate the PP002 probe, connect it to one of the input channels' BNC connectors. Connect the probe's grounding alligator clip to the CAL BNC ground and touch the tip to the inner conductor of the CAL BNC. The CAL signal is a 1 kHz square wave, 1 V p-p.

Set the channel coupling to DC  $1\text{ M}\Omega$ , turn the trace ON and push AUTO SETUP to set up the oscilloscope. If over- or undershoot of the displayed signal occurs, the probe can be adjusted by inserting the small screwdriver, supplied with the probe package, into the trimmer on the probe's barrel and turning it clockwise or counter-clockwise to achieve the optimal square-wave contour.

.....

.....

.....

.....

.....

.....

.....



## 14 Zoom + Math Capabilities

## ZOOM + MATH

A wide range of processing functions can be performed on acquired waveforms. These capabilities are accessed through the ZOOM + MATH controls on the front panel.

Four (processed) traces, A, B, C, and D are available for either zooming alone or for waveform mathematics.

### ZOOM

Any trace, A, B, C or D, can be set up to zoom onto any of the acquired traces C1, C2 (C3, C4), any of the reference memories M1 – M4 (see Chapter 20 on storing waveforms), or any of the other traces A, B, C or D (but not itself). The Displayed Trace field will show the source of the ZOOM. The four rotary knobs of this front-panel section are used to manipulate the horizontal and vertical positions and the horizontal and vertical expansion factors of the zoomed trace. When several traces are displayed, the controls must be assigned to the desired trace with the SELECT A B C D button, since only one trace can be modified at a time.

### Precise Timing Measurements With Zooming

Even on the models with 10K points per channel, the horizontal expansion factor can be as large as 200, greatly improving the time resolution on the viewed trace. It is possible to have several traces zoom onto the same waveform for precise timing measurements.

As an example, consider a waveform where the time interval between two signal transitions that are about 500  $\mu$ s apart must be measured accurately. This waveform should be acquired with a 0.1 ms/div timebase so that the transitions appear on the screen about 5 horizontal divisions apart. Trace A can now be set up to zoom onto the first transition of the signal, while trace B is set up to zoom onto the second transition.

In an instrument with 50K points per channel, the traces can be expanded to as much as 0.1  $\mu$ s/div, i.e. a factor 1000. By applying the "relative" "horizontal" cursors (see Chapter 22), the 500  $\mu$ s time interval can be measured with a resolution of better than 5 ns. Thus, the combination of long memory with zooming allows time interval measurements with an accuracy of 1 to 100000.

### Multi-Zoom

It is sometimes convenient to be able to move the zoomed (intensified) region along two or more different traces, or two or more regions of the same trace, simultaneously. When the Multi-Zoom feature is turned on in the MATH SETUP menu, the horizontal zoom and position controls apply simultaneously to all displayed traces A,

## ZOOM + MATH

B, C and D, allowing a convenient simultaneous viewing of similar sections of different traces. The vertical controls still act individually on the traces, and can be switched from one trace to another with the SELECT A B C D button. The boxes around the trace titles in the Displayed Trace Field show whether the Multi-Zoom is on or off.

### Viewing Reference Memories

The reference memories M1 – M4 cannot be displayed directly. They must be viewed through one of the traces A, B, C or D, and the menu MATH SETUP is used to define the trace as a zoom on the desired reference memory. A shortcut is available in the menu RECALL WAVEFORM (Chapter 21), in which it is possible to "recall" a reference waveform into one of the traces A, B, C or D. Whenever such a "recall" is executed, the destination trace is redefined as a zoom of the reference memory and the trace display is turned on. The previous definition of the destination trace is lost.

### WAVEFORM MATHEMATICS

Any trace A, B, C or D can be set up as a mathematical function. Waveform negation, identity, addition, subtraction, multiplication and division, as well as summed averaging of up to 1000 waveforms, are standard. The waveform processing options WP01 and WP02 offer a wide range of additional possibilities:

- continuous averaging
- summed averaging of up to 1,000,000 waveforms
- enhanced resolution by up to 3 bits with filtering
- extrema, i.e. envelope of many waveforms
- mathematical functions, such as integral, derivative, logarithm, exponential, square, square root and  $\sin x/x$  interpolation
- Fast Fourier Transform (option WP02), including FFT averaging

Waveform mathematics can be applied to any channel C1, C2 (C3, C4) or any reference memory M1 – M4. Also, they can be applied to the traces A, B, C or D so that several computations can be executed in sequence. For example, trace A can be set up as the difference between C1 and C2; then, trace B can be defined as the average of A; finally, trace C can be the integral of B. Thus, trace C displays the integral of the averaged difference between channels 1 and 2.

In order to avoid slowing the instrument down for unwanted computations, a mathematical function is only computed when its display is turned on. However, in the example above, it would be sufficient to

display trace C only: the instrument knows that it must compute A and B as intermediate steps to C.

The Displayed Trace field will show a processing title for each trace on display. If the title is missing, it is an indication that the processing desired cannot be done and the contents of the trace have been left unchanged.

#### **Zoom of Math Functions**

When a trace A, B, C or D is defined as a mathematical function (rather than a Zoom only), the zoom controls are still operating. Thus, it is not necessary to define another trace as a zoom of this function. In order to view the entire mathematical function, cancel any expansion or position change by pressing the button RESET.

#### **Speed-up of Waveform Mathematics**

Waveform processing can take an appreciable execution time when operating on many data points. The time, however, can be reduced by limiting the number of data points which are used in the computation. The instrument then executes the waveform processing function on the entire waveform by taking every Nth point, where N depends on the timebase and the desired maximum number of points. The first point of such a reduced record is always the data value at the left-hand edge of the screen.

#### **What happens when channels are combined?**

Reference and "Zoom & Math" memories match the capacity of the acquisition memories. A 9354M, for instance, with 200K record length per channel will have 200K points in each of the reference memories M1 to M4 and also 200K points for each of the A, B, C and D "Zoom & Math" traces.

Since more acquisition memory — up to 4M on 2-channel L models and up to 8M on 4-channel L models — can be achieved by combining two or four channels, one single 8M trace can "eat up" all of the reference memory capacity in the instrument — or all of its "Zoom & Math" trace capacity. When this is the case, a warning message prevents accidentally storing a new trace to a reference memory already in use.

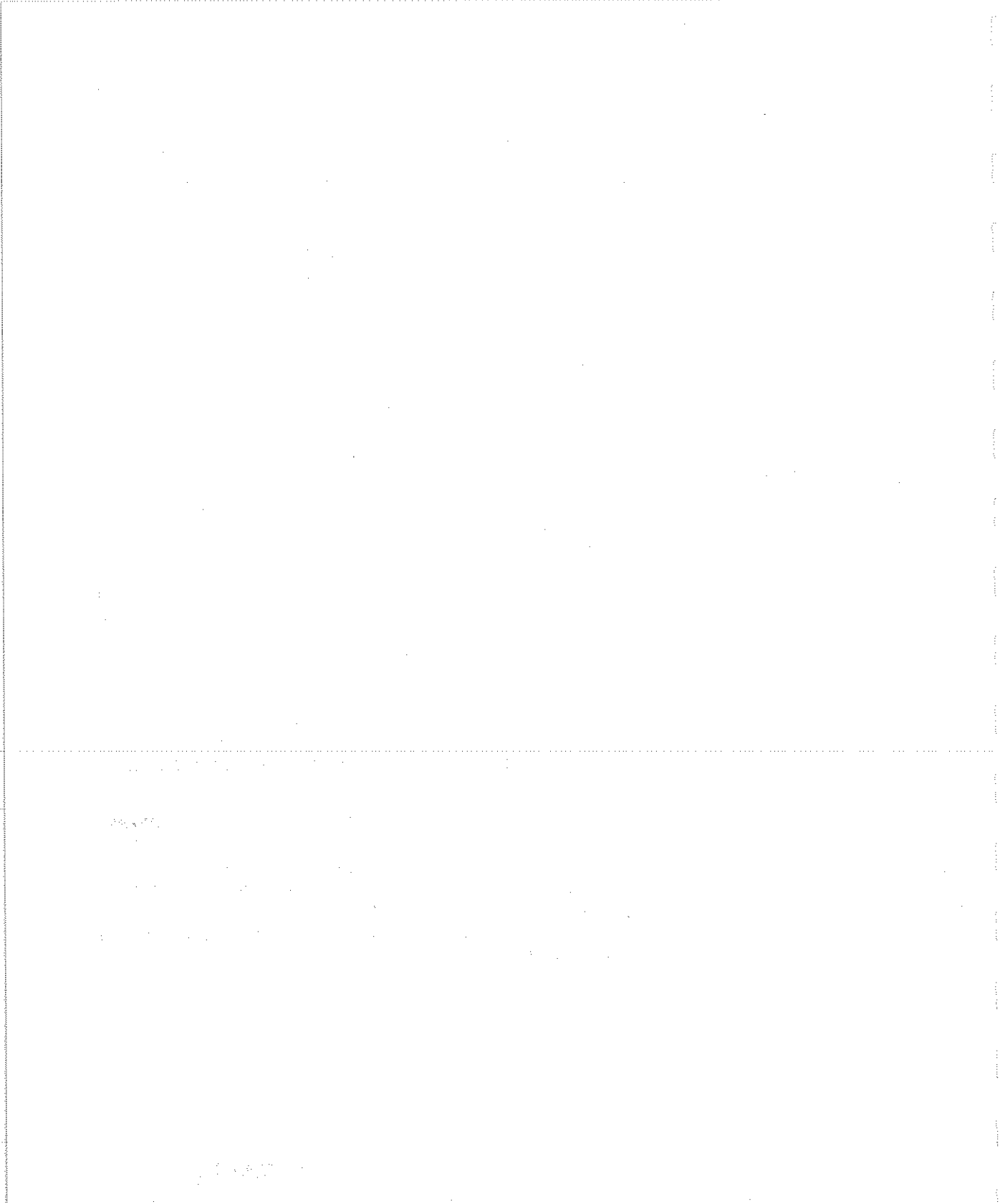

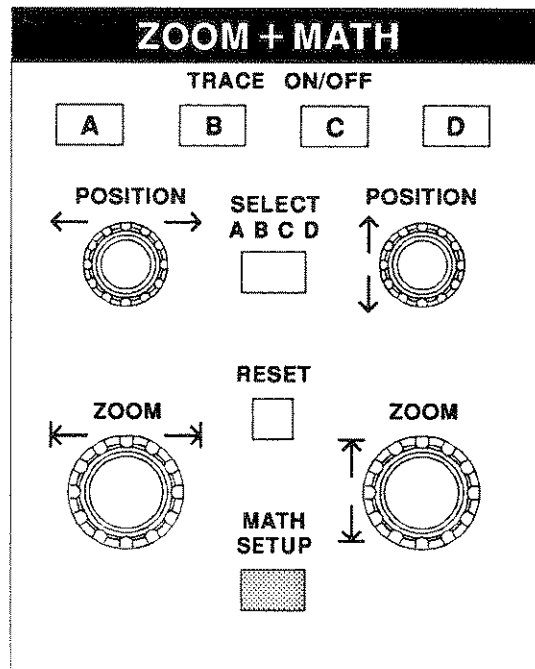

**TRACE ON/OFF**

Pressing a TRACE ON/OFF button causes the corresponding trace (A, B, C or D) to be displayed. The POSITION and ZOOM knobs together with the RESET button will then be attributed to this trace, which will be referred to as the active trace.

**SELECT TRACE**

If more than one trace is displayed, the SELECT ABCD button causes the next trace (in the ABCD sequence) to become active.

**↔ POSITION**

Horizontally repositions an expanded trace. If the source of the expanded waveform is displayed, it will show an intensified region corresponding to the area of expansion.

**↑↓ POSITION**

Vertically repositions the active trace.

## ZOOM + MATH

---

- ↔ ZOOM**                      Horizontally expands/contracts the active trace. If the source of the expanded trace is also displayed, it will show an intensified region corresponding to the area of expansion.
- ↓ ZOOM**                      Vertically expands/contracts the active trace. The ↓ position is adjusted according to the selection made in the SPECIAL MODES menu (Chapter 19).
- RESET**                      This button resets any previously adjusted ↔ POSITION, ↓ POSITION, ↔ ZOOM or ↓ ZOOM to the initial values of the source trace.
- MATH SETUP**              This button calls up the MATH SETUP menu described in Chapter 16. In addition to the definition of the traces A, B, C, D, this menu also controls the multi-zoom mode and the choice of sequence segment displayed by an expand.

The Math Setup menu is used to select:

- Zoom features: vertical, horizontal, multi-zoom, etc...
- Math features: Arithmetic, Average, Enhanced Resolution, Envelope, Fast Fourier Transform (FFT), and various functions such as integral, exponential, square root...
- A sequence segment to be displayed (see Chapter 8 for a description of Sequence mode).

**HOW TO USE MATH**

Four traces (A,B,C,D) are provided for "Math" usage. They can be configured to execute any Zoom or Math function, AND they can be chained. For instance:

- Trace A can be configured to be an averaging of Channel 1
- Trace B can be a Fourier Transform (FFT) of A
- Trace C can be a Zoom of B

All these traces can be seen SIMULTANEOUSLY on the screen by pressing the required TRACE ON/OFF buttons. Also, any function can be zoomed directly.

**STANDARD AND OPTIONAL PROCESSING PACKAGES**

The standard Waveform Processing features of the instrument include Summed Averaging up to 1000 sweeps and Arithmetic operations (Add, Subtract, Multiply, Divide, Negate, Identity).

The WP01 optional Waveform Processing firmware adds the following functionalities:

- Summed Averaging up to 1 million sweeps, Continuous Averaging up to 1024 sweeps, Reciprocate, Rescale, Absolute Value, Derivative, Integral, Logarithm (e), Logarithm (10), Exponential (e), Exponential (10), Square, Square Root, (sin x)/x interpolation
- Enhanced Resolution: Digital filtering allows 0.5- to 3-bit vertical resolution improvement.

The WP02 optional Waveform Processing firmware adds frequency domain analysis (FFT and FFT Power Averaging), as well as Rescale in both time and frequency domains.

**ZOOM + MATH**

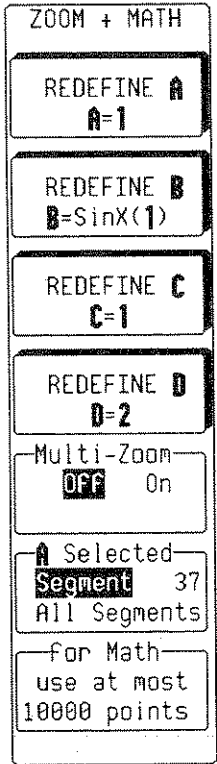

**REDEFINE**

Selects the trace to be redefined in the Setup menu. The various Setup menus are described in the rest of this chapter.

**Multi-Zoom**

When Multi-Zoom is ON, all the "Zoom" traces are simultaneously controlled by the POSITION and ZOOM knobs.

When Multi-Zoom is switched OFF, only the active trace (selected by pressing the SELECT ABCD button) is controlled by the POSITION and ZOOM buttons.

**Selected**

When a trace A...D that contains a Sequence mode waveform is selected, this box appears in the menu. It is used to select either a specific segment to be displayed in the trace or all the segments at once. Pressing the menu button toggles between a single **Segment** and **All Segments**. When a single segment is selected, the associated rotary knob can be used to step through the segments.

**for Math use at most...**

Selects the maximum number of points for all Math operations. Selecting a low number increases computation speed.



SETUP MENU FOR ZOOM

SETUP OF A

use Math?

No  Yes

Trace A is  
ZOOM of

<input type="checkbox"/>	2	3	4	B	C	D
M1	M2	M3	M4			

**use Math?**  
Toggles between **No** (Zoom only) and **Yes** (Math + Zoom) setup.

**Trace ... is ZOOM of**  
Selects the source trace on which the zoom will be applied.

**ZOOM + MATH**

**SETUP MENU FOR ARITHMETIC**

This menu allows addition, subtraction, multiplication and division. The two operands and the operator may be chosen in the three lower fields.

The menu illustrated on this page shows a setup of trace A as the sum of Channel 1 and Channel 2.

SETUP OF A

use Math?  
No **Yes**

Math Type  
**Arithmetic**  
Average  
Enh. Res  
Extrema  
FFT

**Sum**  
Difference  
Product  
Ratio

**1 2 3 4 B C D**  
**M1 M2 M3 M4**

plus

**1 2 3 4 B C D**  
**M1 M2 M3 M4**

**use Math?**

Select **Yes**.

**Math Type**

Select **Arithmetic**.

## SETUP MENU FOR AVERAGE

This menu allows summed (linear) averaging or continuous (exponential) averaging.

**Summed averaging** consists of the repeated addition, with equal weight, of successive source waveform records. If a stable trigger is available, the resulting average has a reduced random noise component, compared with a single-shot record. Whenever the maximum number of sweeps is reached, the averaging process stops. The process may be interrupted by switching the trigger mode from NORM to STOP or by turning the function trace OFF. Averaging will continue when these actions are reversed.

The accumulated average may be reset by either pushing the CLEAR SWEEPS button or by changing an acquisition parameter, such as input gain, offset or coupling, trigger condition, timebase or bandwidth limit. The number of currently averaged waveforms (of the function or of its expansion) is displayed in the Displayed Trace field.

Whenever the maximum number of sweeps is reached, a larger number of sweeps may be accumulated by simply changing the maximum number of sweeps in the setup menu. In this case care must be taken to leave the other parameters unchanged, otherwise a new averaging calculation is started.

When summed averaging is turned on, the display is updated at a reduced rate (about once every 1.5 s), to increase the averaging speed (points per second and events per second).

Summed averaging can be applied to sequence waveforms to give the average of the segments. It can also be applied to an expansion showing a segment of a sequence, to give the average waveform for that segment over many sequence acquisitions.

**Continuous averaging** (also called exponential averaging) consists of the repeated addition, with unequal weight, of successive source waveforms. The technique is particularly useful for reducing noise on signals that drift very slowly in time or amplitude. However, the statistics of a continuous average tend to be worse than those from a summed average on the same number of sweeps, since the most recently acquired waveform has more weight than all previously acquired ones. Therefore, the continuous average is dominated by the statistical fluctuations of the most recently acquired waveforms.

The weight of "old" waveforms in the continuous average gradually tends to zero, at a rate that decreases as the weight increases.

**ZOOM + MATH**

The menu below shows a setup of trace A as a Summed Average – over 1000 sweeps – of Channel 1.

SETUP OF <b>A</b>
use Math? No <b>Yes</b>
Math Type Arithmetic <b>Average</b> Enh. Res Extrema FFT
Avg Type <b>Summed</b> Continuous
for 1000 (sweeps)
of <b>1</b> 2 3 4 B C D M1 M2 M3 M4

**use Math?**

Select **Yes**.

**Math Type**

Select **Average**.

**Avg Type**

Selects between **Summed** and **Continuous Average**.

**for... / weight**

In Summed Averaging mode, this field is used to define the number of sweeps desired for the operation. In Continuous Averaging mode, this field is used to define the weight (similar to the number of sweeps) desired for the operation.

In other words, in summed averaging, "for n sweeps" means the *first* n sweeps will be taken into account. In continuous averaging, "weight 1 : n" means that the last sweep will be given a weight of 1 and the previous result a weight of n in calculating the new average.

**of**

Selects the source trace to be averaged.

**SETUP MENU FOR ENHANCED RESOLUTION**

This menu allows the selection of low-pass digital filters that increase the resolution of the displayed signal to the detriment of its bandwidth. Appendix B gives a detailed explanation.

*Note: These digital filters work very much like analog bandwidth-limit filters. In single-shot mode, these filters, as well as the sampling speed, affect bandwidth. If high bandwidth is needed at slow timebases, consider using averaging and repetitive sampling.*

SETUP OF A

use Math?  
No **Yes**

Math Type  
Arithmetic  
Average  
**Enh. Res**  
Extrema  
FFT

enhance by  
1 bit  
1.5 bits  
**2 bits**  
2.5 bits  
3 bits

<input type="checkbox"/>	2	3	4	B	C	D
	M1	M2	M3	M4		

**use Math?**

Select Yes.

**Math Type**

Select Enhanced Resolution.

**enhance by**

Selects the different filters which will enhance the resolution of the displayed signal from 1 to 3 bits in 0.5-bit steps. The last box on the menu allows selection of the source trace to be filtered.

**SETUP MENU FOR  
EXTREMA**

This menu is used to acquire the envelope of a trace over many acquisitions.

Extrema waveforms are computed by a repeated comparison of successive source waveform records with the already accumulated extrema waveform, which consists of a maxima record (roof) and a minima record (floor). Whenever a given data point of the new waveform exceeds the corresponding maximum value in the roof record, it replaces it. If the new data point is smaller than the corresponding floor value, it replaces it. Thus the maximum and the minimum envelope of all waveform records is accumulated.

**Roof and Floor** records can be displayed individually or both together.

Whenever the selected maximum number of sweeps is reached, the accumulation process stops. The process may be interrupted by switching the trigger mode from NORM to STOP or by turning the function trace OFF. Accumulation will continue when these actions are reversed. The currently accumulated extrema waveform may be reset by either pushing the CLEAR SWEEPS button or by changing an acquisition parameter, such as input gain, offset or coupling, trigger condition or the timebase or bandwidth limit. The number of currently accumulated waveforms is displayed in the Displayed Trace field of the function or of its expansion.

A larger number of sweeps may be accumulated by simply changing the maximum number of sweeps in the setup menu. In this case, care must be taken to leave the other parameters unchanged, otherwise the extrema calculation is started again.

SETUP OF **A**

use Math?  
 No  Yes

Math Type  
 Average  
 Enh. Res  
**Extrema**  
 FFT  
 FFTAVG

limits  
**Envelope**  
 Floor Roof

for  
 1000  
 (sweeps)

of  
 2 3 4 B C D  
 M1 M2 M3 M4

**use Math?**

Select **Yes**.

**Math Type**

Select **Extrema**.

**limits**

Selects between **Envelope**, **Floor** and **Roof**. **Floor** is used to show only the lower part of the envelope, and **Roof** to show only the upper part of the envelope. Changing the limits does not force the analysis to start again.

**for**

Selects the number of sweeps desired for the operation.

**of**

Selects the source trace.

**ZOOM + MATH**

**SETUP MENU FOR FFT**

This menu is used to display the Fast Fourier Transform (FFT) of a signal in order to visualize it in the frequency domain. More details of Fast Fourier Transform are given in Appendix C.

```

SETUP OF A
  use Math?
  No Yes
  Math Type
  Enh. Res
  Extrema
  FFT
  FFTAVG
  Functions
  FFT result
  Phase
  Power Dens
  Power Spect
  Real
  Real+Imag
  with
  Hamming
  (window)
  of
  2 3 4 B C D
  M1 M2 M3 M4
  
```

**use Math?**

Select Yes.

**Math Type**

Select FFT.

**FFT result**

Selects the output format of the FFT: **Imaginary**, **Magnitude**, **Phase**, **Power Density**, **Power Spectrum**, **Real**, **Real + Imaginary**.

**with**

Selects the FFT window type: Rectangular, Hanning, Hamming, Blackman-Harris, Flat-top.

**of**

Selects the source trace.

**FFT INTERRUPTION (ABORT)**

During FFT computation the symbol FFT is displayed in the lower right-hand corner of the screen). Since the computation of FFT on long time-domain records may take a long time, it is possible to interrupt an FFT computation with any front-panel button or knob.



**SETUP MENU FOR  
FFT AVERAGE**

This menu is used to display the FFT power averaging of an FFT source trace.

Power averaging is useful for the characterization of broadband noise or of periodic signals for which a stable trigger signal is not available. Note that this type of averaging measures the total power (signal and noise) at each frequency.

*Note: The source trace must be an FFT function.*

SETUP OF A
use Math? No <b>Yes</b>
Math Type Extrema FFT <b>FFT AVG</b> Functions Rescale
FFT result Magnitude Power Dens <b>Power Spect</b>
for 1000 (sweeps)
of <b>B C D</b>

**use Math?**

Select Yes.

**Math Type**

Select FFT AVG.

**FFT result**

Selects the output format of the FFT Average: **Magnitude, Power Density, Power Spectrum.**

**for**

Selects the number of sweeps desired for the operation.

**of**

Selects the FFT source.

The FFT AVERAGE can be reset by pushing the CLEAR SWEEPS button. The number of currently accumulated waveforms is displayed in the Displayed Trace field of the function or its expansion.

## ZOOM + MATH

---

### SETUP MENU FOR FUNCTIONS

This menu is used to display any of the following functions:

- Absolute value
- Derivative
- Exp (base e)
- Exp 10 (base 10)
- Identity
- Integral
- Log (base e)
- Log 10 (base 10)
- Negation
- Reciprocal
- Sinx/x
- Square
- Square root

*Notes:*

*Square Root is actually computed on the absolute value of the source waveform.*

*For logarithmic and exponential functions the numerical value (without units) of the input waveform is used.*

*For the integral function the source waveform may be offset by an Additive Constant in the range  $-10^{16}$  to  $+10^{16}$  times the vertical unit of the source waveform.*

SETUP OF A

use Math?  
No **Yes**

Math Type  
Extrema  
FFT  
FFTAVG  
**Functions**  
Rescale

Function  
Negation  
Reciprocal  
**SinX**  
Square  
Square Root

of

1	2	3	4	B	C	D
M1	M2	M3	M4			

use Math?

Select Yes.

Math Type

Select Functions.

Function

Selects the function type.

of

Selects the source trace.

**ZOOM + MATH**

**SETUP MENU FOR RESCALE**

This menu is used to select a waveform and adjust the multiplication factor a and the additive constant b in:

$$(a * \text{waveform}) + b$$

Both constants can have values between  $-10^{15}$  and  $+10^{15}$ .

SETUP OF

use Math?  
No **Yes**

Math Type  
Extrema  
FFT  
FFTAvg  
Functions  
**Rescale**

\* 1) + b

a =  
**+1.00** E+00  
3 digits

2 3 4 B C D  
M1 M2 M3 M4

**use Math?**

Select **Yes**.

**Math Type**

Select **Rescale**.

Use the button next to  $(a * 1) + b$  to highlight either a or b.

**a = (or b =)**

Use this button to highlight the mantissa, the exponent, or the number of digits.

Use the knob to change the highlighted value.

The last box on the menu allows selection of the source waveform to be rescaled.

## 17 Menu Buttons & Knobs

## MENU CONTROLS

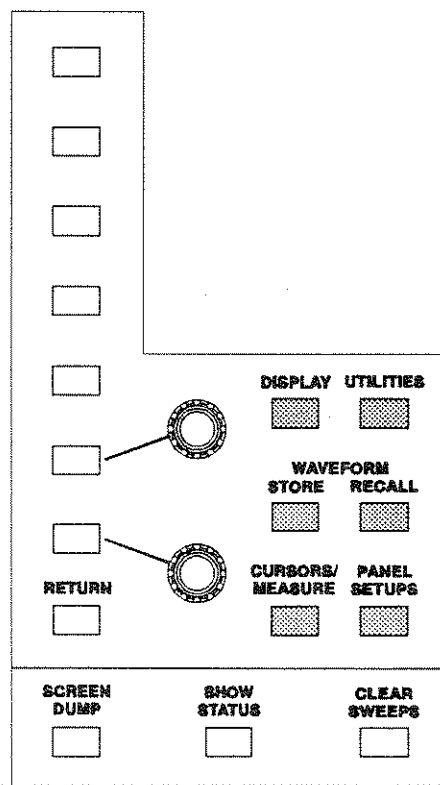

### MENU BUTTONS

When a menu is activated by pressing one of the dark-grey menu-entry keys on the front panel, up to seven fields appear on the right-hand side of the display. These fields can be controlled by using one of the seven menu buttons.

The eighth (bottom) button marked RETURN is used to go back to a higher-level menu, or – when at the highest possible level – to switch the menu off.

### MENU KNOBS

The two menu knobs are associated with the last two menu fields. Both the button and the adjacent knob provide control of the field. For example, the button may be used to step through a list of parameters and the knob used to set the selected parameter's value.

## MENU CONTROLS

---

<b>DISPLAY</b>	This button calls up the DISPLAY menu, described in Chapter 18, which controls grids, intensities, persistence modes, etc.
<b>UTILITIES</b>	This button calls up the UTILITIES menu, described in Chapter 19, which controls printer setups, GPIB addresses, etc.
<b>WAVEFORM STORE</b>	This button calls up the WAVEFORM STORE menu, described in Chapter 20, which is used to store waveforms to internal memory or external memory.
<b>WAVEFORM RECALL</b>	This button calls up the WAVEFORM RECALL menu, described in Chapter 21, which is used to retrieve waveforms stored on cards or floppy disks.
<b>CURSORS/MEASURE</b>	This button calls up the CURSORS/MEASURE menu, described in Chapter 22, for precise cursor and parameter measurements on traces.
<b>PANEL SETUPS</b>	This button calls up the PANEL SETUPS menu, described in Chapter 23, which is used to save or recall a configuration of the instrument.
<b>SCREEN DUMP</b>	<p>Causes a print or plot of the current screen display to an on-line hardcopy device, via the oscilloscope's GPIB or RS-232-C interface ports. All the screen illustrations included in this manual were produced using the Screen Dump function.</p> <p>Once the SCREEN DUMP button has been pressed, <i>all</i> the displayed information will be copied. It is possible to copy the waveforms without also copying the grid, by turning the grid intensity down to 0 in the Display Setup menu.</p> <p>While a screen dump is taking place, as indicated by the PRINTING or PLOTTING message on the lower right part of the screen, it can be aborted by pressing the SCREEN DUMP button a second time. Allow some time for the buffer to empty before copying stops.</p> <p><i>Note: See Chapter 19, UTILITIES for HARDCOPY SETUP.</i></p>

**MENU CONTROLS**

---

**CLEAR SWEEPS**

Many operations require several acquisitions (referred to as sweeps), among which are averaging (see Chapter 16 for description of AVERAGE menu), persistence, and pass/fail testing. The CLEAR SWEEPS button "restarts" these operations by resetting the sweep counter(s) to zero.

**GENERAL INSTRUMENT  
RESET**

To reset the instrument, simultaneously press the AUTO SETUP button, the top menu-button, and the RETURN button. The instrument will revert to its default power-up settings.





## 18 Display

### MENU CONTROLS

The Display menu is used to select:

- Standard or XY mode
- Persistence OFF or ON
- The number of grids on screen
- The intensity adjustments for the waveforms and text
- The intensity adjustments for the grids

#### Standard Display vs. XY Display

The standard display allows the presentation of source waveforms versus time (or versus frequency for FFTs).

The XY display allows the presentation of one source waveform versus another.

The XY display can be generated if the traces selected have the same time or frequency span (same T/div) and have the same horizontal unit (second or Hertz). As soon as two compatible traces are selected, the XY display is automatically generated. If incompatible traces are selected, a warning message is displayed at the top of the screen. If the two compatible traces are not matched in time, their XY diagram will still be displayed with an indication of the shifting – in time or in frequency – between the two traces. The  $\Delta T$  or  $\Delta f$  indicator is displayed in the displayed trace field on the left of the screen.

**MENU CONTROLS**

**Persistence**

In Persistence Display – available in both Standard and XY mode – the oscilloscope can display points so that they accumulate on screen over many acquisitions. "Eye diagrams" and "Constellation displays" can be achieved using this display mode. The most recent sweep is displayed as a "vector" trace over the persistence display. This feature, however, is not available in XY or in Sequence mode.

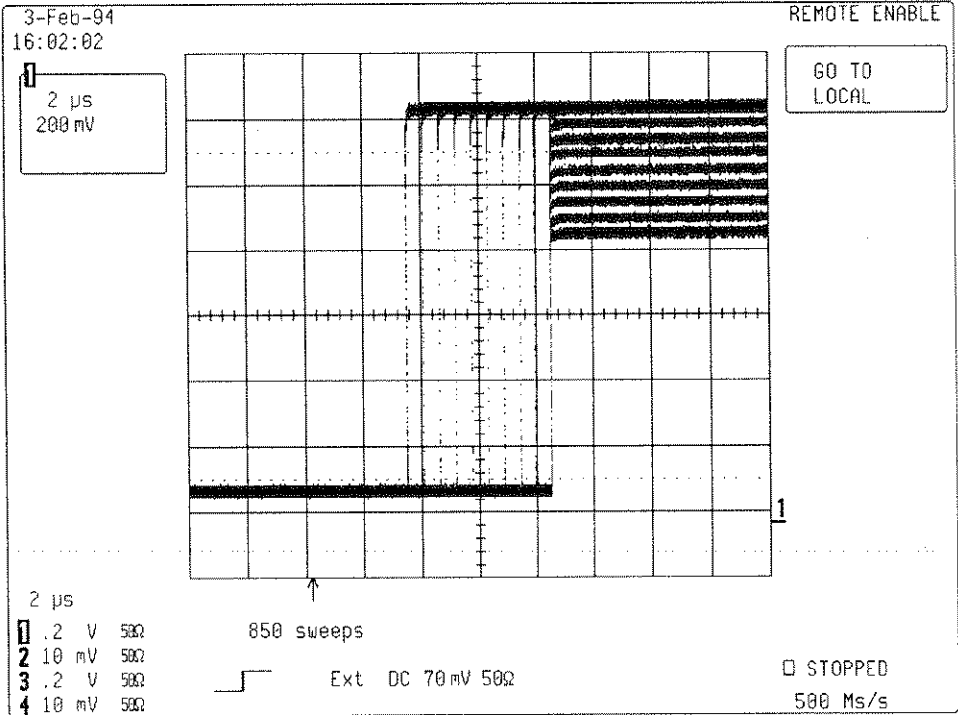

**MENU CONTROLS**

**Screen Presentation**

Grid sizes and presentations depend on whether the instrument is in Standard or in XY display.

The "Parameter" display can only be chosen in Standard display with persistence OFF, by accessing the CURSORS/MEASURE menu and selecting parameters or PASS/FAIL. In "Parameter" display, only single-grid presentation is available.

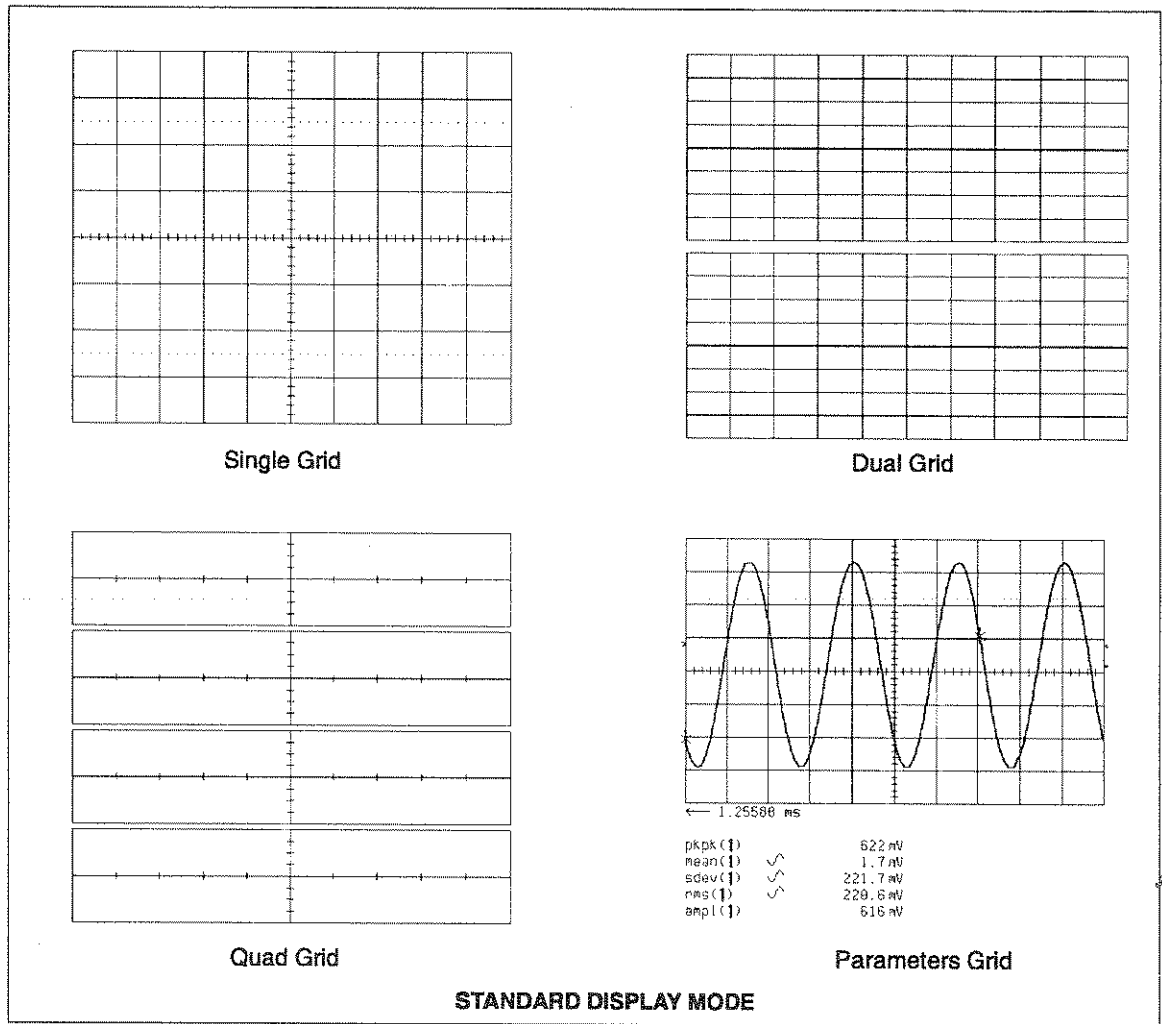

**MENU CONTROLS**

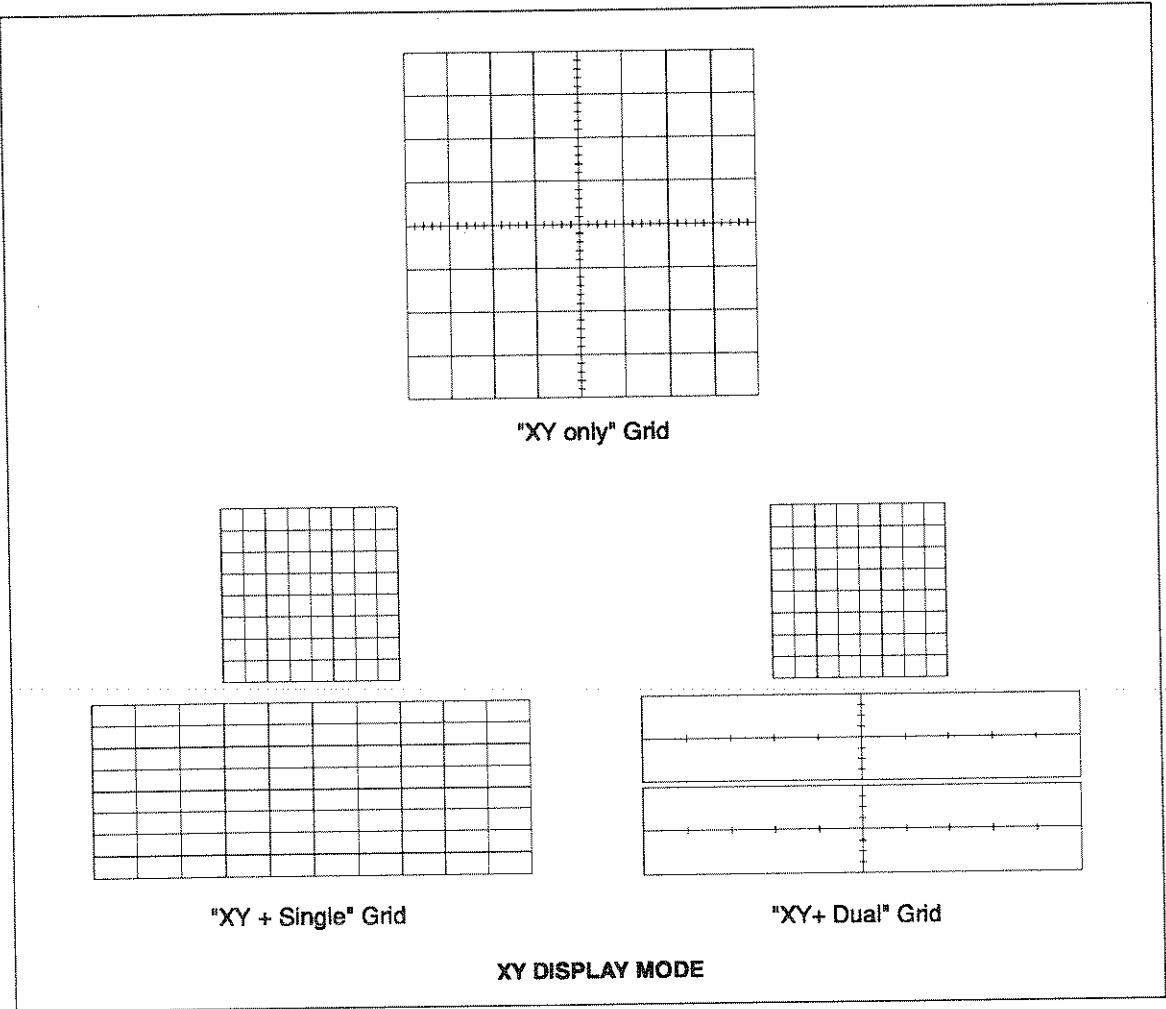

**STANDARD DISPLAY**

DISPLAY SETUP
<b>Standard</b> XY
Persistence <b>OFF</b> On
Dot Join <b>OFF</b> On
<b>MORE DISPLAY SETUP</b>
Grids <b>Single</b> Dual Quad
W'form+Text intensity 90 %
Grid intensity 60 %

**Persistence**

Selects the persistence mode. When set to ON, can be cleared and reset by pressing the CLEAR SWEEPS button or by changing any acquisition condition, any waveform processing condition, or the number of grids.

**Dot Join**

When set to ON, connects the sample points with a line segment. When set to OFF, only the sample points are displayed.

**MORE DISPLAY SETUP**

Calls the persistence setup menu.

**Grids**

Selects the desired number of grids. If the "Parameters" or the "PASS/FAIL" mode is selected in the CURSORS/MEASURE menu, then only the single grid is available.

**W'form + Text intensity**

Adjusts the screen intensity for waveforms and text, using the attributed menu knob.

**Grid intensity**

Adjusts the screen intensity for grids, using the attributed menu knob. If the grid intensity is turned down to 0, the grids will not show on a screen dump.

## MENU CONTROLS

### XY DISPLAY

DISPLAY SETUP
Standard <input checked="" type="checkbox"/> XY
Persistence OFF <input checked="" type="checkbox"/> On (10s)
Dot Join <input checked="" type="checkbox"/> OFF On
MORE DISPLAY SETUP
Grids <input checked="" type="checkbox"/> XY only Single Dual
W'form+Text intensity 90 %
Grid intensity 60 %

#### Persistence

Selects the persistence mode. When set to ON, can be cleared and reset by pressing the CLEAR SWEEPS button or by changing any acquisition condition, any waveform processing condition, or the number of grids. The number of sweeps accumulated (up to 1000000) is displayed below the grid. Persistence is not available for traces with more than 50000 points (L models only).

#### Dot Join

When set to ON, connects the sample points with a line segment. When set to OFF, only the sample points are displayed.

#### MORE DISPLAY SETUP

Calls the persistence setup menu.

#### Grids

Selects the desired number of grids. In "XY only" mode, the XY grid occupies the maximum possible space on screen. In Single Grid, a smaller square grid is used for the XY display while the rectangular grid underneath simultaneously shows the original source waveforms. The rectangular grid can also be used in a dual grid mode by selecting Dual Grid.

#### W'form + Text intensity

Adjusts the screen intensity for waveforms and text, using the attributed menu knob.

#### Grid intensity

Adjusts the screen intensity for grids, using the attributed menu knob. If the grid intensity is turned down to 0, the grids will not show on a screen dump.

**MORE DISPLAY**

MORE DISPLAY

Persistence  
All traces  
Top 2

Persist for  
0.5 1  
2 5  
10 20  
Infinite

**Persistence**

Selects whether persistence is applied to all or to the two top traces.

**Persist for**

Selects the persistence duration, in seconds.

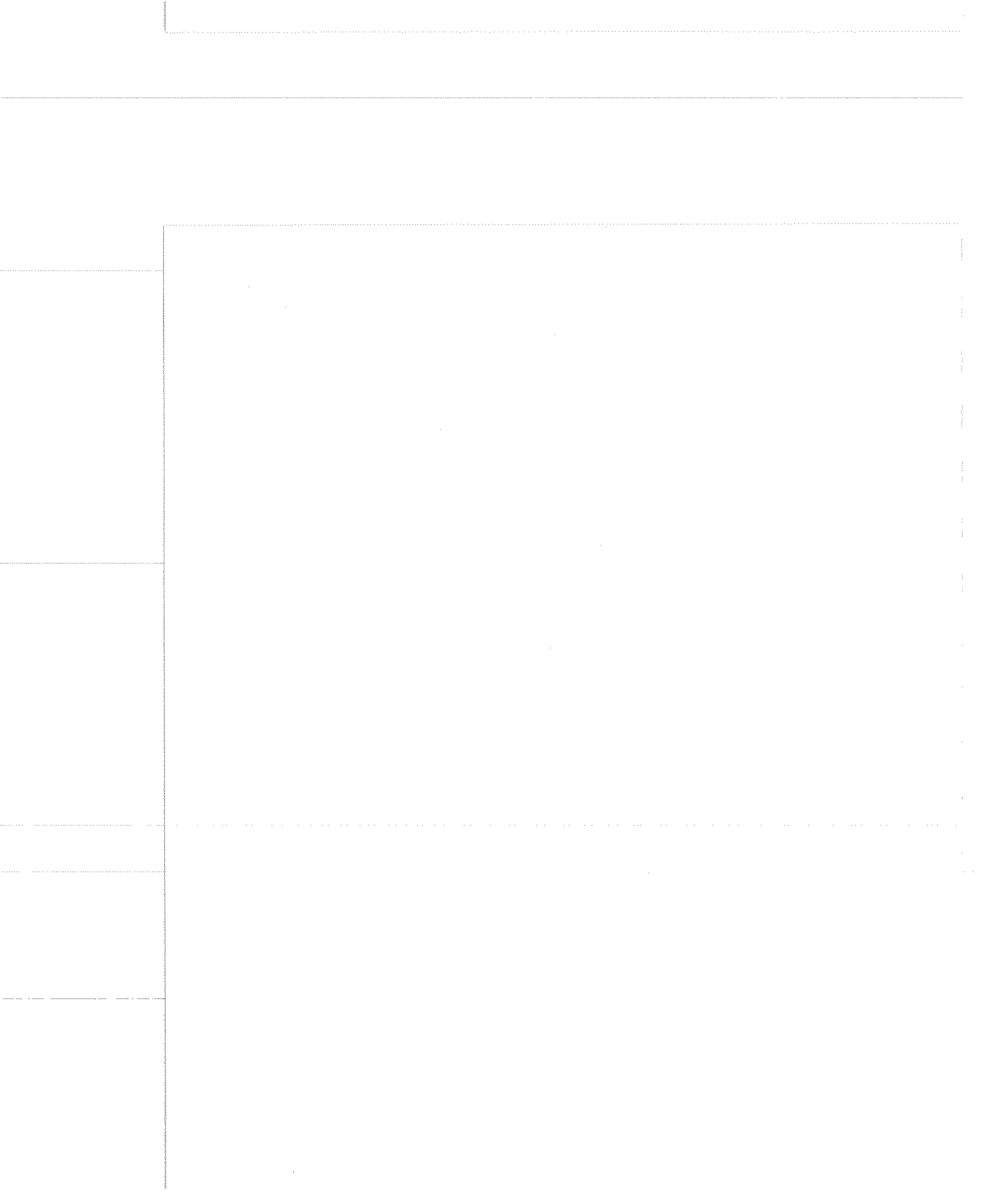



This section describes the Utilities menu which is used to select:

- The hardcopy settings.
- The time and date settings for the real-time clock.
- The GPIB and RS232 settings.
- The memory card or floppy disk utilities (copy and format, delete files...).
- The Special Modes of operation (offset behavior, sequence time-out).
- The function of the signal at the CAL BNC connector (magnitude, frequency, shape, trigger out, pass/fail use).

#### UTILITIES MAIN MENU

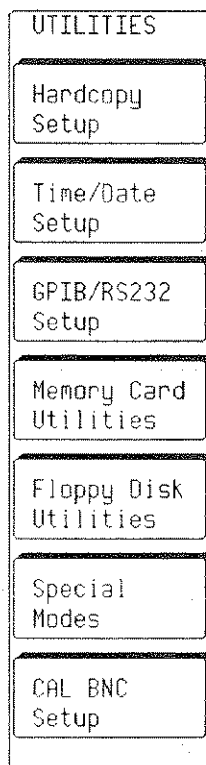

#### Hardcopy Setup

Press this button to view/change the current printer or plotter settings.

#### Time/Date Setup

Press this button to adjust the real-time clock displayed in the upper left corner of the screen.

#### GPIB/RS232 Setup

Press this button to view/change the current interface settings.

#### Memory Card Utilities

Press this button to access the Memory Card Utilities menu.

#### Floppy Disk Utilities

Press this button to access the Floppy Disk Utilities menu.

#### Special Modes

Press this button to access the Special Modes menu.

#### CAL BNC Setup

Press this button to access the CAL BNC menu. This button only appears in instruments with the CLBZ hardware option.

**MENU CONTROLS**

**HARDCOPY SETUP MENU**

HARDCOPY	
output to	
Card	
Disk	
<b>GPIB</b>	
RS232	
Centronics	
page feed	
<b>OFF</b>	On
plotter	
DeskJet b/w	
HP 7470	
<b>HP 7550</b>	
TIFF	
TIFF compr.	
plot size	
A5(8.5"/5.5")	
<b>A4 (11"/8.5")</b>	
pen number	
2	

**output to**

Selects the device to which the instrument should output. If using a port, check the GPIB & RS232 menu to make sure that the settings are correct.

The device can be either a port (RS232, GPIB, Centronics) to which a plotter or printer is connected, a storage unit (card, floppy), or the internal printer. The list of devices shows the options installed in the instrument.

When copying to a storage unit, a file name will be assigned automatically, following the rules set out in the file-naming section.

**page feed**

Select **On** to start on a new page each time the SCREEN DUMP button is pressed.

**plotter/printer protocol**

Use the menu buttons to select the appropriate driver.

*Note: Press the SCREEN DUMP button on the front panel to make a copy of the current screen display.*

**plot size (for plotters only)**

Selects the desired size: A4 (11" x 8.5"), A5 ( 8.5" x 5.5").

**pen number (for plotters only)**

Selects the number of pens installed on the plotter. The oscilloscope assumes the pens are loaded consecutively in the lower slots.

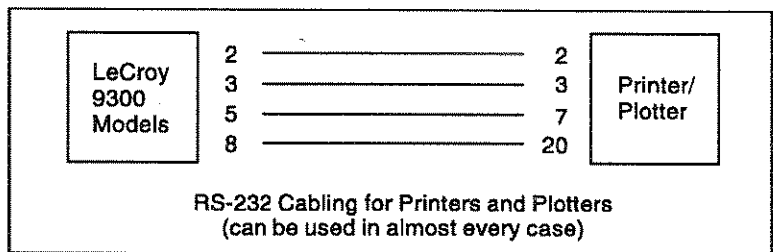

INTERNAL PRINTER SETUP MENU

HARDCOPY

output to

Int. Printer

Card

Floppy

GPIB

RS232

cm/division

1	2
5	10
20	50
100	200

**output to**

Select Internal Printer.

**cm/division**

Select the appropriate expansion factor.

*Note: A "persistence" trace cannot be expanded. Also, cursors do not show on an expanded printout.*

**MENU CONTROLS**

**TIME/DATE MENU**

A vertical menu control panel with the following elements from top to bottom:

- A rectangular display area containing the text "TIME/DATE".
- A button labeled "SET CLOCK FORWARD ONE HOUR (SPRING)".
- A button labeled "SET CLOCK BACKWARD ONE HOUR (FALL)".
- A button labeled "LOAD CHANGES NOW".
- A blank rectangular area.
- A display screen showing "Hour Min Sec" and "14:51:12".
- A display screen showing "Day Mnth Year" and "29 MAR 1993".

**SET CLOCK...(SPRING)**

Press this button to switch to summer time.

**SET CLOCK...(FALL)**

Press this button to switch to winter time.

**LOAD CHANGES NOW**

Activates the changes made with the "Hour/Min/Sec" and "Day/Month/Year" buttons and knobs.

**Hour/Min/Sec**

Press the menu button to toggle between "hour", "minutes", and "seconds". Use the menu knob to adjust the corresponding value.

**Day/Mnth/Year**

Press the menu button to toggle between "day", "month", and "year". Use the menu knob to adjust the corresponding value.

**GPIB & RS232 MENU**

GPIB & RS232	
Remote Control from	<b>GPIB</b> RS232
RS232 Mode	7-bit <b>8-bit</b>
Parity	<b>none</b> odd even
Stop bits	<b>1</b> 2
Baud Rate	300 1200 2400 4800 <b>9600</b> 19200
GPIB Device (Address)	4

**Remote Control from**

Selects the port for remote control.

*Note: When RS-232 is selected, the GPIB interface is in "Talk Only" mode.*

**RS232 Mode**

Selects 7-bit or 8-bit mode for RS-232 communication.

**Parity**

Selects the parity for RS-232 communication.

**Stop bits**

Selects the number of stop bits for RS-232 communication.

**Baud Rate**

Selects the appropriate baud rate, using the attributed menu knob.

**GPIB Device (Address)**

Selects the appropriate GPIB address.

*Note: Any change becomes immediately effective.*

## MENU CONTROLS

### RS-232-C CONNECTOR

The RS-232-C port on the rear panel can be used for remote oscilloscope operation, as well as for direct interfacing of the oscilloscope to a hardcopy device to produce copies of displayed waveforms and other screen data.

While a printer or plotter unit is connected to the oscilloscope, its RS-232-C port can be computer controlled from a host computer via the GPIB port. The oscilloscope's built-in drivers allow hard copies to be made without an external computer.

#### RS-232-C connector pin assignments:

DB9 Pin #		Description
3	T × D	Transmitted data (from the oscilloscope).
2	R × D	Received data (to the oscilloscope).
7	RTS	Request to send (from the oscilloscope). If the software Xon/Xoff handshake is selected, it is always TRUE. Otherwise (hardware handshake) it is TRUE when the oscilloscope is able to receive characters and FALSE when the oscilloscope is unable to receive characters.
8	CTS	Clear to send (to the oscilloscope). When TRUE, the oscilloscope can transmit; when FALSE, transmission stops. It is used for the oscilloscope output hardware handshake.
4	DTR	Data terminal ready (from the oscilloscope). Always TRUE.
—	GND	Protective ground.
5	SIG GND	Signal ground.

This corresponds to a DTE (Data Terminal Equipment) configuration.

**MEMORY CARD UTILITIES MENU (optional)**

This menu displays information about the memory card loaded into the oscilloscope:

- Last "format" date and time
- Memory size and available free space
- Date, time and size information of the selected file on the card (highlighted in the bottom menu-field)

In addition, this menu provides access to the following operations:

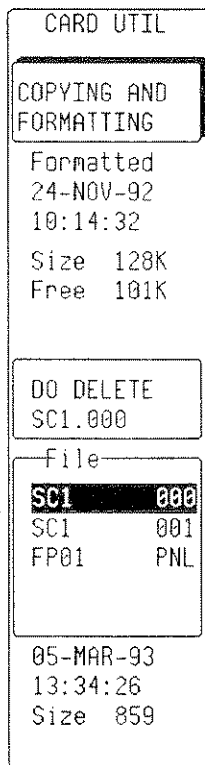

**COPYING AND FORMATTING**

Select this menu to format the card or to copy the machine template to the card. The template is an ASCII text-file which contains all the information required to decode the descriptor part of a binary waveform.

**DO DELETE**

Deletes the file selected at the bottom of the menu.

**File**

Selects the file to be deleted, using the attributed menu knob or buttons.

*Note: When the instrument is equipped with both the memory card (MC01) and the floppy disk ((FP01) options, a "File Transfers" sub-menu appears, allowing file transfers between the storage media (see page 19-12).*

## MENU CONTROLS

---

### MEMORY CARD AND FLOPPY DISK STRUCTURE

#### MC Format

The Memory Card's structure, based on the PCMCIA 1.0/JEIDA 4.0 standard, consists of a DOS partition containing files as in any DOS floppy or hard disk.

When the card is formatted by the oscilloscope it is segmented in contiguous sectors of 512 bytes each. The oscilloscope does not support error detection algorithms such as CRC's or checksum that are inserted between the sectors. In this case, the oscilloscope may still be able to read the card but be unable to write to the card.

#### Floppy Disk Format

The floppy disk supports DOS 1.44 Mb and 720 Kb formats.

#### LeCroy Subdirectory

All the files are written to the media in a subdirectory called LECROY\_1.DIR. This directory is automatically created when the media is formatted. If the media has been formatted elsewhere – for instance in a PC – the directory will be created the first time a file is stored to the memory card or to the floppy disk.

#### File-naming Structure

As in MS-DOS, the file name can take up to 8 characters followed by an extension of 3 characters.

A file is treated as:

- a Panel setup if its extension is PNL.
- a Waveform if its extension is a 3-digit number.
- a Waveform Template if its extension is TPL.
- a Hardcopy if its extension is TIF, PRT or PLT.

If the file you are storing carries the same name as a file already on the media, the old file will be deleted.

When the instrument stores a file, it automatically generates pre-defined filenames as follows:

- Panels: **Pnnn.PNL**. nnn denotes a 3-digit decimal sequence number. The first panel saved on the media will be P001.PNL, the second will be P002.PNL, etc.
- Waveform: **Axx.nnn** or **Sxx.nnn**. xx defines the trace name:
  - C1, C2, C3, C4 for Channel 1, Channel 2, Channel 3, Channel 4 traces.
  - TA, TB, TC, TD for functions



The file's first letter A stands for an autostored file, while S stands for an individually stored file. Files from a computer should not be given names beginning with an "A" character as this could cause them to be overwritten by an Autostore routine.

nnn denotes a 3-digit decimal sequence number. The first "Channel 1" waveform stored to the media will be SC1.001, the second will be SC1.002, etc.

- Template: **LECROYxx.TPL**. xx stands for the version of the template. If the version is 2.1 for example, the template file will be saved as LECROY21.TPL.
- Hardcopy: **Dxxx.TIF** if the hardcopy is set to TIF, **Dxxx.PRT** if the hardcopy is set to any selection of printers, **Dxxx.PLT** if the hardcopy is set to any selection of plotters.

#### More on Autostored Files

If the "Fill" option is selected, the first waveform stored will be Axx.001, the second Axx.002, and so on until the media is full or until the file number reaches 999.

If the "Wrap" option is selected, the oldest autostored waveform files will be deleted whenever the media becomes full. Remaining autostored waveform files are renamed, the oldest group of files being named "Axx.001", the second oldest "Axx.002", etc.

#### Write Protect Switch

At the back of the memory card or the floppy disk you will find a write protection switch that may be activated to prevent writing to the card or disk. A "Device is Write Protected" message will then be displayed on the upper part of the grid whenever the media is accessed for writing.

#### Battery

Every SRAM memory card contains a small battery to preserve the data. It is a button-size type BC2325 or CR2325 battery and it can be changed when necessary. The oscilloscope will warn you with a "BAD BATTERY" message that the battery has to be changed. To access the battery, remove the small lid on the upper edge of the card. The battery can be changed even when the memory card is still installed in the oscilloscope. In fact, it should be changed while it is inserted in the oscilloscope in order to prevent loss of information on the card while it is temporarily without a battery.

**MENU CONTROLS**

**FLOPPY DISK UTILITIES  
MENU (optional)**

This menu displays information about the floppy disk installed in the oscilloscope:

- Last "format" date and time
- Media size and available free space
- Date, time and size information of the selected file on the floppy disk (highlighted in the bottom menu-field)

In addition, this menu provides access to the following operations:

```
DISK UTIL
COPYING AND
FORMATTING
Formatted
18-MAR-93
10:08:56
Size 1440K
Free 1114K

DO DELETE
P003.PNL

File
P003 PNL
SC1 020
SC2 020
SC1 021
SC2 021

25-FEB-93
10:25:52
Size 1907
```

**COPYING AND FORMATTING**

Select this menu to format the disk or to copy the machine template to the disk. The template is an ASCII text-file which contains all the information required to decode the descriptor part of a binary waveform.

**DO DELETE**

Deletes the file selected in the box below.

**File**

Selects the file to be deleted, using the attributed menu knob or buttons.

**MENU CONTROLS**

This menu appears every time a disk operation is required:

- if a new disk is inserted in the drive.
- if no disk is present in the drive.

DISK UTIL

(RE-)READ  
DRIVE

Please  
insert Floppy  
+ push menu  
button above

**RE-READ DRIVE**

Reads the disk and displays the contents of the directory.

## MENU CONTROLS

FORMAT DISK !FORMATTING ERASES ALL INFO ON DISK
PERFORM DISK FORMAT
Density 1.44 MB (HD) 720 KB (DD)
COPY TEMPLATE TO DISK
REORDER ALL FILES BY DATE
File Transfers

### PERFORM DISK FORMAT

Formats the floppy disk with a density of 1.44 Mb or 720 Kb, selectable in the box below. The disk will have a DOS format, with an interleave factor of 2 to optimize throughput to and from the oscilloscope.

#### Density

Select density desired – **1.44 Mb (HD)** or **720 Kb (DD)**.

### COPY TEMPLATE TO DISK

Copies the machine template to the disk. The template is an ASCII text-file which contains all the information required to decode the descriptor part of a binary waveform.

### REORDER ALL FILES BY DATE

Reorders the disk so that the directory listing shows the files sorted by date.

### File Transfers

This menu field appears when the instrument is equipped with both the memory card (MC01) and the floppy disk (FP01) options, and allows file transfers between the two storage media.

**MENU CONTROLS**

**COPY FILES**

Direction  
**Card -> Disk**  
Disk -> Card

Which files  
Panels  
Prints  
Auto Wfms  
Norm Wfms  
**All Files**

**DO COPY**

!OVERWRITES  
FILES WITH  
SAME NAME

**Direction**

Select the copy source → destination.

**Which files**

Choose the file types to be copied.

**DO COPY**

Copies the selected files.

## MENU CONTROLS

### SPECIAL MODES MENU

SPECIAL MODES  
On GAIN  
changes, all  
OFFSETS Fixed

in  
**Volts**  
Divisions

Read time  
cursor  
amplitudes

in  
**Volts**  
dBm

AUTO sequence  
times out  
100.0000 s  
after last  
segment

#### Offsets... in

Specifies the offset behavior on a gain (VOLTS/DIV) change. The offset can be fixed either in Volts or in vertical Divisions.

#### time cursor amplitudes... in

Selects the time cursor units in volts or dBm.

#### AUTO sequence

Specifies the time-out in Sequence mode (see Chapter 8). Use the associated menu knob to change the value.

**CAL BNC OUT MENU**

The type of signal put out at the CAL BNC connector can be controlled from this menu. It is used to select:

- The frequency of the calibration signal (CLBZ hardware option)
- The amplitude of the calibration signal (CLBZ hardware option)
- The pulse shape for the calibration signal (CLBZ hardware option)

Furthermore, with the CKIO software option, the CAL BNC connector can be used to provide a pulse:

- at the occurrence of each trigger
- as an action for PASS/FAIL testing

Note that when the instrument is turned on, the calibration signal is automatically set to its default state (1kHz 1V square wave).

The menu is shown here as it appears for an instrument with the CKIO software option.

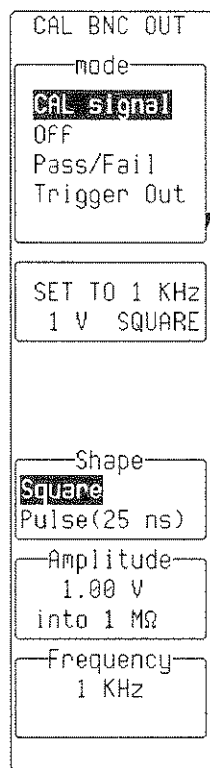

**mode**

Press this button to change the kind of signal made available.

**SET TO**

Press this button to quickly reset the CAL BNC output to its default state.

**Shape**

Press this button to change the form of the calibration signal.

**Amplitude**

Use the knob to set the desired high level for all uses of the CAL BNC.

**Frequency**

Use the knob to set the desired frequency of a CAL signal in the range 500 Hz to 2 MHz.

## 20 Waveform Store

## MENU CONTROLS

The Waveform Store menu is used to select:

- The waveform(s) to be stored to internal memory, to the memory card (optional), or to the floppy disk (optional).
- Automatic storage to the memory card (Auto-store) (optional), or to the floppy disk (optional).
- Auto-store mode: stop when media is full or "wraparound" as in a circular buffer (optional).

STORE W'FORMS	
Size 1440K Free 1114K	
Auto-Store <input checked="" type="checkbox"/> OFF Wrap <input type="checkbox"/> Fill	
DO STORE (4->Disk)	
store 1 2 3 4 A B C D All displayed	
to M1 M2 M3 M4 Card <input checked="" type="checkbox"/> Disk	

### Auto-Store

Appears only when storage to memory card or floppy disk is selected in bottom menu box. Select **Auto-Store** to automatically store waveforms after each acquisition.

Two kinds of Autostore mode can be selected: **Fill** stores acquired waveforms until the media becomes full, and **Wrap** stores continuously to the media, discarding the oldest autostored files in a first-in-first-out manner.

### DO STORE

Use this menu button to perform the STORE operation based on the instructions given in the two following menu boxes.

### store

Selects the waveform to be stored. "All displayed" will automatically select storage to the memory card (see below).

### to

Selects either one of the internal memories (M1 to M4), the memory card (optional), or the floppy disk (optional).

*Note: Reference and "Zoom & Math" memories match the capacity of the acquisition memories. A 9354M, for instance, with 200K record length per channel will have 200K points in each of the reference memories M1 to M4 and also 200K points for each of the A, B, C and D "Zoom & Math" traces.*

*As more acquisition memory – up to 4M on 2-channel L models and up to 8M on 4-channel L models – can be achieved by combining two or four channels, one single 8M trace can "eat up" all of the reference memory capacity in the instrument – or all of its "Zoom &*



**MENU CONTROLS**

---

*Math" trace capacity. When this is the case, a warning message is given to prevent accidentally storing a new trace to a reference memory already in use.*

The Recall Waveform menu is used to recall a waveform from one of the internal memories, from the memory card (optional), or from the floppy disk (optional).

### RECALLING FROM AN INTERNAL MEMORY

```

RECALL W' FORM
-----
From
Memories
Card Disk

DO RECALL
M2 -> B

from Memory
M1
M2
M3
M4

to
A B C D
  
```

from

Select Memories.

DO RECALL

This menu button is used to perform the RECALL operation based on the instructions given in the two following menu boxes. At the same time, the horizontal and vertical positions and zooms are reset to show the full contents of the memory at its original magnification.

from Memory

Selects source memory.

to

Selects the destination trace.

*Note 1: Performing a recall operation from an internal memory to a trace A...D overrides any previous definition of the destination trace. (See Chapter 14, Zoom + Math Capabilities).*

*Note 2: Reference and "Zoom & Math" memories match the capacity of the acquisition memories. A 9354M, for instance, with 200K record length per channel will have 200K points in each of the reference memories M1 to M4 and also 200K points for each of the A, B, C and D "Zoom & Math" traces.*

*As more acquisition memory — up to 4M on 2-channel L models and up to 8M on 4-channel L models — can be achieved by combining two or four channels, one single 8M trace can "eat up" all of the reference memory capacity in the instrument — or all of its "Zoom & Math" trace capacity. When this is the case, a warning message is given to prevent accidentally storing a new trace to a reference memory already in use.*

**MENU CONTROLS**

**RECALLING FROM A MEMORY CARD OR FLOPPY DISK**

RECALL W'FORM

from  
Memories  
Card **Disk**

26-FEB-93  
14:22:26  
Size 47817

DO RECALL  
SC2.020

File

SC1	020
<b>SC2</b>	<b>020</b>
SC1	021
SC2	021

to  
**M1 M2 M3 M4**

**from**  
Select **Card** or **Disk**.

**DO RECALL**  
This menu button is used to perform the **RECALL** operation, based on the instructions given in the two following menu boxes.

**File**  
Selects the waveform file, using the attributed menu knob.

**to**  
Selects the destination memory.

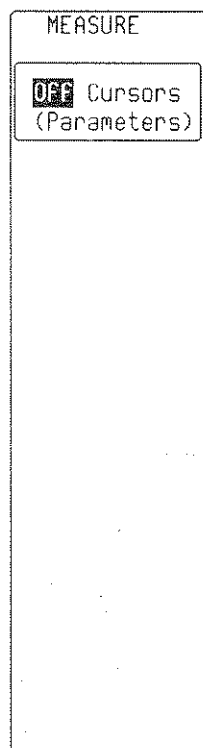
**CURSORS IN STANDARD DISPLAY**

Cursors provide basic tools for measuring signal values. Vertical cursors can be moved in steps as small as 1/64 of a division to measure signal amplitudes with 0.2% resolution. Horizontal cursors can be placed at a desired time to read the amplitude of a signal at that time, and can be displaced in time with a resolution of 2000 steps across the grid width (0.05% of the entire displayed time span).

In Absolute mode, one cursor can be manipulated and amplitude, or time and amplitude, readings are provided. Amplitudes relate to ground, and times relate to trigger times.

In Relative mode, two cursors can be manipulated, providing readings of the difference in amplitude, or time and amplitude, between the two cursors.

Amplitudes are always shown in the trace label field for each trace. For horizontal cursors, the time is shown below the grid. In Relative mode, the frequency corresponding to the time interval between the two cursors is also displayed here. When the horizontal scale implies that less than 500 digitized points fill the screen, the oscilloscope interpolates, using straight line segments between actual data points. If 200 points or less are used, the digitized points are clearly visible as intensified points on the screen. When a cursor is placed on an actual data point, horizontal bars appear on the cursor.

When there are more than 500 digitized points, the trace is displayed on the screen with a resolution of 500 display points. A compacting algorithm showing all minimum and maximum values ensures that no information is lost when a trace is displayed. Time cursors can be positioned on any one of the 500 display points of a compacted trace.

Note that setting the cross-hair marker to 0 time provides a visual indication of the trigger point.

**CURSORS IN PERSISTENCE DISPLAY**

Voltage cursors are similar to those in standard display mode. Time cursors consist of vertical bars which are placed on the desired part of the displayed waveform.

**CURSORS IN XY DISPLAY**

As in the standard display, time and voltage cursors can be used in the XY display.

Absolute voltage cursors show as a vertical and a horizontal bar.

**MENU CONTROLS**

Relative voltage cursors show as a pair of vertical and a pair of horizontal bars.

Absolute and Relative time cursors are similar to those in standard display mode.

Combinations of the vertical values (voltages) are shown on the left side of the square grid:

- (1) The ratio  $\Delta Y \text{ value} / \Delta X \text{ value}$
- (2) The ratio in dB units  $20 * \log_{10}(\text{ratio})$
- (3) The product  $\Delta Y \text{ value} * \Delta X \text{ value}$
- (4) The distance to the origin  $r = \text{sqrt}(\Delta X * \Delta X + \Delta Y * \Delta Y)$
- (5) The angle (polar)  $q = \text{arc tan}(\Delta Y / \Delta X)$   
range  $[-180^\circ \text{ to } +180^\circ]$ .

Cursors					
	$V_{Abs}$	$V_{Rel}$	$T_{Abs}$		$T_{Rel}$
			Org = (0,0)	Org = $V_{XOffset}$ $V_{YOffset}$	
$\Delta X$	$V_{XRef} - 0$	$V_{XDif} - V_{XRef}$	$V_{XRef} - 0$	$V_{XRef} - V_{XOffset}$	$V_{XDif} - V_{XRef}$
$\Delta Y$	$V_{YRef} - 0$	$V_{YDif} - V_{YRef}$	$V_{YRef} - 0$	$V_{YRef} - V_{YOffset}$	$V_{YDif} - V_{YRef}$

The definition of  $\Delta X$  and  $\Delta Y$  is dependent on the type of cursors used. The following table shows how  $\Delta X$  and  $\Delta Y$  are defined for each type of measurement.

Where

- $V_{Abs}$  = Absolute Voltage cursors
- $V_{Rel}$  = Relative Voltage cursors
- $T_{Abs}$  = Absolute Time cursors
- $T_{Rel}$  = Relative Time cursors
- Org = Origin
- $V_{XRef}$  = Voltage of the reference cursor on the X trace
- $V_{YRef}$  = Voltage of the reference cursor on the Y trace
- $V_{XDif}$  = Voltage of the difference cursor on the X trace
- $V_{YDif}$  = Voltage of the difference cursor on the Y trace

**AUTOMATIC MEASUREMENTS**

Certain signal properties can be determined automatically, using a parameter measurement mode. The following table lists all the parameters that can be determined by the instrument. Appendix D describes the methods employed to determine these parameters.

Statistical variations of these signal parameters over several successively captured signals can be observed as average, standard, and extreme deviations.

**PASS/FAIL**

Pass/Fail tests can be performed using these parameter measurements. These tests require a combination of parameter measurements to be within chosen limits, and provoke an action if the test either passes or fails. Alternatively, the pass/fail test can be a test of a signal against a tolerance mask.

## MENU CONTROLS

PARAMETER	ABBREV.	EXPLANATION
amplitude	ampl.	Absolute value of the top minus the base.
area	area	Sum of sampled values between cursors times the duration of a sample.
base	base	First of two most probable states. This is characteristic of rectangular waveforms and represents the first most probable state determined from the statistical distribution of data point values in the waveform.
cycles	cycles	Number of pairs of transitions in the same direction.
delay	delay	Time from trigger to the midpoint of the first transition.
$\Delta$ delay	$\Delta$ dly	Time between midpoint transition of two sources.
$\Delta$ t at level	$\Delta$ t@lv	Time between selectable transition levels of two sources or time from trigger to a selectable transition level.
duty cycle	duty	Width as a percentage of period.
fall time	fall	Duration of the pulse waveform's falling transition from 90% to 10%, averaged for all falling transitions between the cursors.
fall 80-20%	f80-20%	Duration of the pulse waveform's falling transition from 80% to 20%, averaged for all falling transitions between the cursors.
fall at level	f@level	Duration of the pulse waveform's falling edges between selectable transition levels.
first	first	Time from trigger to first (leftmost) cursor.
frequency	freq	Reciprocal of period.
last	last	Time from trigger to last (rightmost) cursor.
maximum	maximum	Maximum value of the trace between the cursors.
mean	mean	Average or DC level of the waveform. If the waveform is periodic, it is computed over an integral number of periods.
median	median	The average of base and top values.
minimum	minimum	Minimum value of the trace between the cursors.
overshoot negative	oversh-	Lower most probable value minus the minimum sample value, expressed as a percentage of the amplitude.
overshoot positive	oversh+	Maximum sample value minus the higher most probable value, expressed as a percentage of the amplitude.
peak-to-peak	pkpk	Difference between the maximum and the minimum values.

**MENU CONTROLS**









<b>PARAMETER</b>	<b>ABBREV.</b>	<b>EXPLANATION</b>
period	period	Time of a full cycle averaged for all full cycles between the cursors.
points	points	Number of points between the vertical cursors.
rise time	rise	Duration of the pulse waveform's rising transition from 10% to 90%, averaged for all rising transitions between the cursors.
rise 20-80%	r20-80%	Duration of the pulse waveform's rising transition from 20% to 80%, averaged for all rising transitions between the cursors.
rise at level	r@level	Duration of the pulse waveform's rising edges between selectable transition levels.
root mean square	rms	Square root of sum of squares, divided by number of terms. If waveform is periodic, it is computed over an integral number of periods.
standard deviation	sdev	Square root of sum of squares of difference from mean, divided by number of terms. If the waveform is periodic, it is computed over an integral number of periods.
top	top	Second of two most probable states. Characteristic of rectangular waveforms and represents the second most probable state determined from the statistical distribution of data point values in the waveform.
width	width	Width of the first pulse (either positive or negative), averaged for all similar pulses between the cursors.



**MENU CONTROLS**

**PARAMETER INFORMATION AND WARNING SYMBOLS**

The algorithms which determine the pulse waveform parameters are capable of detecting certain situations where the mathematical formulas may be applied but the results obtained must be interpreted with caution. In these cases, the name of the parameter and its value are separated on the screen by a graphic symbol. The symbols and their meanings are indicated in the figure below.

<b>INFORMATION</b>	
	Parameter has been determined for several periods (up to 100), and the average of those values has been taken
	Parameter has been determined over an integral number of periods
	Insufficient data to determine a parameter
<b>WARNINGS</b>	
	i.e., amplitude histogram is flat within statistical fluctuations. Minimum and maximum are used to assign base and top
	Only an upper limit could be estimated (actual value of parameter may be smaller than displayed value)
	Signal is partially in overflow
	Signal is partially in underflow
	Signal is partially in overflow and partially in underflow

**CURSORS MENU**

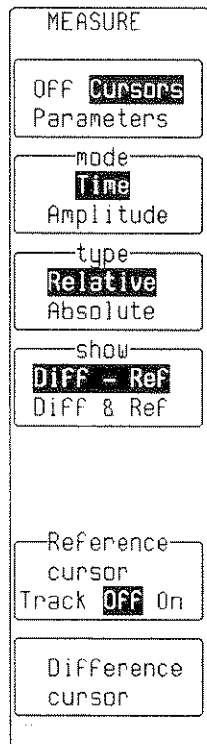

**Off/Cursors/Parameters**

Select **Cursors**.

**mode**

Selects **Time** (time or frequency) or **Amplitude** (voltage or amplitude) cursors.

**type**

Toggles between **Relative** and **Absolute**. **Relative** displays two cursors – reference and difference – and indicates either the voltage or the time and voltage between the two cursors. **Absolute** displays one cursor that indicates either a voltage compared to the ground level, or a time compared to the trigger point and a voltage compared to the ground level.

**show**

**Diff – Ref** shows the subtraction between the difference– and the reference–cursor amplitudes.

**Diff & Ref** shows the amplitude values for each of the cursors.

**Reference cursor**

Available with the **Relative** type cursors. The corresponding menu knob controls the Reference cursor.

When **Track** is ON, both Reference and Difference cursors are controlled by this knob and move together, keeping a constant time or voltage interval between them. This tracking interval is represented by a bar (horizontal for time, vertical for voltage) that appears either on the top (time) or on the left (voltage) edge of the grid.

**Difference cursor**

Available with the **Relative** type cursors. The corresponding menu knob controls the Difference cursor.

## MENU CONTROLS

---

### PARAMETERS MENU

Parameters can be measured in two standard classes, making commonly needed measurements on a single signal in either the amplitude domain or the time domain.

Parameter measurements can be customized to determine up to five quantities from the list in the table at the beginning of this chapter on different signals. These customized parameter measurements can also be used for pass/fail testing against chosen limits.

For all of these modes, statistics on the parameter values are accumulated and can be displayed. In addition to the overall number of sweeps used, each parameter has its average, lowest and highest value. The standard deviation of the parameter is also calculated.

### STANDARD VOLTAGE PARAMETERS

This class of parameters measures for one trace:

- Peak-to-Peak (amplitude between maximum and minimum sample values)
- Mean of all sample values (corrected for periodic signals)
- Standard Deviation (equivalent to RMS-DC component)
- RMS of all sample values (corrected for periodic signals)
- Amplitude of the signal

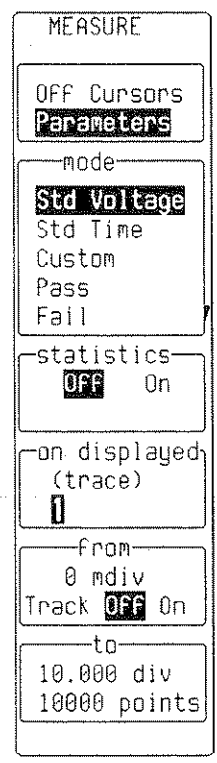

#### Off/Cursors/Parameters

Select **Parameters**.

#### mode

Select **Standard Voltage** parameters.

#### statistics

This shows the average, the lowest, the highest, and the standard deviation of a parameter, as well as the number of sweeps included in the statistics. The number of sweeps is cleared each time the acquisition conditions change, or by pressing the CLEAR SWEEPS button.

The accumulation of statistics continues, even if the statistics are not shown, as long as **Parameters** are selected.

#### on displayed (trace)

Selects the trace for which the voltage parameters are measured.

#### from

Determines the starting point (in screen divisions) for parameter measurements.

#### to

Determines the end point (in screen divisions) for parameter measurements. It also indicates the total number of data points used for the measurements.

## MENU CONTROLS

### STANDARD TIME PARAMETERS

This class of parameters measures for one trace:

- Period
- Width (at 50% amplitude)
- Risetime (10–90% of amplitude)
- Falltime (90–10% of amplitude)
- Delay (from trigger to first 50% amplitude point)

MEASURE
OFF Cursors <b>Parameters</b>
mode Std Voltage <b>Std Time</b> Custom Pass Fail
statistics OFF <b>On</b>
on displayed (trace) <b>1</b>
from 0.00 div Track <b>OFF</b> On
to 10.00 div 500 points

#### Off/Cursors/Parameters

Select **Parameters**.

#### mode

Select **Standard Time** parameters.

#### statistics

This shows the average, the lowest, the highest, and the standard deviation of a parameter, as well as the number of sweeps included in the statistics. The number of sweeps is cleared each time the acquisition conditions change, or by pressing the CLEAR SWEEPS button.

The accumulation of statistics continues, even if the statistics are not shown, as long as **Parameters** are selected.

#### on trace

Selects the trace for which the time parameters are measured.

#### from

Determines the starting point (in screen divisions) for parameter measurements.

#### to

Determines the end point (in screen divisions) for parameter measurements. It also indicates the total number of data points used for the measurements.

**CUSTOM PARAMETERS**

In this parameter measurement mode, up to five parameters selected from the list in the table at the beginning of this chapter can be displayed for different traces.

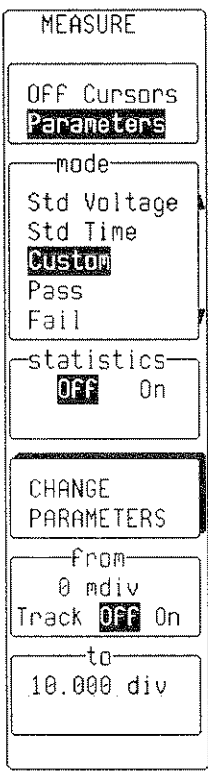

**Off/Cursors/Parameters**

Select **Parameters**.

**mode**

Select **Custom** parameters.

**statistics**

This shows the average, the lowest, the highest, and the standard deviation of a parameter, as well as the number of sweeps included in the statistics. The number of sweeps is cleared each time the acquisition conditions change, or by pressing the CLEAR SWEEPS button.

The accumulation of statistics continues, even if the statistics are not shown, as long as **Parameters** are selected.

**CHANGE PARAMETERS**

The Change Parameters menu is used to select the quantities and the traces for which these quantities are to be measured (see description given subsequently in this chapter).

**from**

Determines the starting point (in screen divisions) for parameter measurements.

**to**

Determines the end point (in screen divisions) for parameter measurements.

## MENU CONTROLS

### ADDING OR DELETING CUSTOM PARAMETERS

This menu is used to choose the custom parameters that need to be displayed.

CHANGE PARAM
On line
<input checked="" type="checkbox"/> 1 2 3 4 5
DELETE ALL PARAMETERS
measure
--
<input checked="" type="checkbox"/> ampl
area
base
cycles
of
<input checked="" type="checkbox"/> 2 3 4
A B C D

#### on line

Up to five different parameters are displayed, each on a separate line. This button selects the line to be modified.

#### DELETE ALL PARAMETERS

Deletes all parameters previously selected.

#### measure

Selects the new parameter to be measured on this line.

#### of

Selects the trace on which the parameter will be measured.

**PARAMETERS THAT REQUIRE SETUP**

The following parameters may be customized to meet specific needs:

- $\Delta t@lv$
- $f@level$
- $r@level$

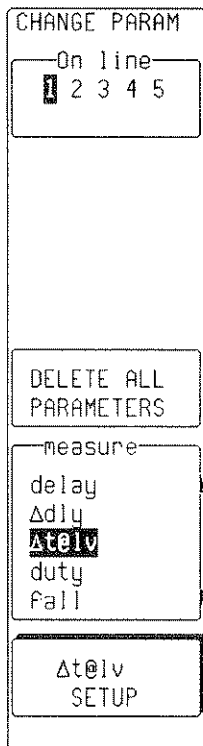

**Online**

Up to five different parameters are displayed, each on a separate line. This button selects the line to be modified.

**DELETE ALL PARAMETERS**

Deletes all parameters previously selected.

**measure**

Set at  $\Delta t@lv$ .

**$\Delta t@lv$  SETUP**

Calls the  $\Delta t@lv$  customization menu.



## MENU CONTROLS

### PARAMETERS THAT REQUIRE SETUP (Customize Menu)

$\Delta t$ from
1 rising through 25 mV
to 1 falling through 106 mV
mode
<b>absolute</b> percent
From
<b>to</b>
edge
Pos <b>Neg</b> First Trigger
at level
106 mV
of
<b>2</b> A B C D

#### mode

Selects whether the levels should be set in absolute values or in "relative-to-base-and-top" values.

#### from/to

Activates the settings for the source or destination traces.

#### edge

Determines where the timing should start or finish: **Pos** for rising edge, **Neg** for falling edge, **First** for "either positive or negative edges". **Trigger** means the timing should start or finish at the trigger point.

#### at level

Selects the level on the trace at which the timing should start or finish.

#### of

Selects the trace.

**PASS/FAIL TESTING**

PASS/FAIL testing can be performed in two different ways:

**1. PASS/FAIL tests on parameters**

Up to five parameters can be tested simultaneously against limits.

**2. PASS/FAIL tests on a tolerance mask**

A trace is compared to a tolerance mask.

Whether the test PASSES or FAILs, any or all of the following actions can be provoked:

- Stop capturing further signals
- Dump the screen image to a hardcopy unit
- Store selected traces to internal memory, to a memory card (optional), or to a floppy disk (optional)
- Sound the buzzer
- Emit a pulse on the CAL BNC

The Pass/Fail display shows the results on the current waveforms, the number of events passing and the total number of sweeps treated, as well as the actions to be taken.

## MENU CONTROLS

MEASURE
OFF Cursors Parameters
mode
Std Voltage Std Time Custom Pass Fail
testing
OFF On
CHANGE TEST CONDITIONS
from
0.01 div Track OFF On
to
10.00 div

### Off/Cursors/Parameters

Select Parameters.

#### mode

Select Pass or Fail.

#### testing

Testing can be disabled in order to observe only the parameter variations.

### CHANGE TEST CONDITIONS

The Change Test Conditions menu is used to choose the class of tests, the quantities and traces to be measured and their limits, or the tolerance mask, as well as the actions to be performed according to the result of the test (see description given subsequently in this chapter).

#### from

Determines the starting point (in screen divisions) for parameter measurements.

#### to

Determines the end point (in screen divisions) for parameter measurements.

**CHANGE PASS/FAIL TEST ON PARAMETERS**

CHANGE TEST	
On line	1 2 3 4 5
	Action
Test on	Param Mask
	---(No Test)
choose	Param Limit
DELETE ALL TESTS	
measure	--
	ampl
	area
	base
	cycles
of	1 2 3 4
	A B C D

**on line**

Up to five different parameters are displayed, each on a separate line. This menu button selects the line to be modified. To change **Action** see page 22-22.

**test on**

Set to test on **Param** (for tests on **Masks** see page 22-19). Set to **...(No Test)** if no test is required on the selected line.

**choose**

Set to **Param**. To change **Limit** see page 22-18.

**DELETE ALL TESTS**

Deletes all tests previously selected.

**measure**

Selects the new parameter to be measured on this line.

**of**

Selects the trace on which the parameter will be measured.

## MENU CONTROLS

### CHANGE LIMITS FOR PASS/FAIL TESTS ON PARAMETERS

CHANGE TEST
On line 1 2 3 4 5 Action
Test on Param Mask ---(No Test)
choose Param Limit
DELETE ALL TESTS
True if < >
limit +0.14 E+01 3 digits
SET TO LATEST VALUE

#### On line

Up to five different tests are displayed, each on a separate line. This button selects the line of the test to be modified.

#### test on

Set to test on **Param** (for tests on **Masks** see page 22-19).

#### choose

Set to **Limit** (to change **Param** see page 22-17).

#### DELETE ALL TESTS

Deletes all tests previously selected.

#### True if

Selects the adequate relation – smaller than < , or greater than >.

#### limit

Three fields can be manipulated separately to modify a limit, its mantissa, its exponent, and the number of digits to represent the mantissa. The menu button is used to choose the field, and the menu knob is used to modify the number in that field.

#### SET TO LATEST VALUE

This menu button is used to set the limit to the latest measured value, to serve as a starting value for the final adjustment.

**CHANGE PASS/FAIL TEST ON A MASK**

CHANGE TEST
On line 1 2 3 4 5 Action
Test on Param Mask ---(No Test)
MODIFY MASK
True if all points some points
of 1 2 3 4 A B C D
inside A B C D

**on line**

Up to five different parameters are displayed, each on a separate line. This menu button selects the line to be modified. To change **Action** see page 22-22.

**test on**

Set to **Mask** (for tests on Parameters see page 22-17). Set to **...(No Test)** if no test is required on the selected line.

**MODIFY MASK**

Use this menu button to modify the mask settings.

**True if**

Selects test condition on the mask.

**of**

Selects trace to be tested.

**inside/outside**

Selects mask trace.

*Note: When performing pass/fail testing against a mask, please note that the test is affected by horizontal and vertical zooming of the mask trace. Also, the test will be made inside the area bordered by the parameter cursors.*

## MENU CONTROLS

### GENERATING A MASK FROM A WAVEFORM

MODIFY MASK
from Card Disk <b>W'form</b>
into <b>D=M4</b> M1 M2 M3 M4
INVERT MASK <b>D=M4</b>
Use W'form <b>1</b> 2 3 4 A B C D M1 M2 M3 M4
MAKE MASK <b>D=M4</b>
delta V 0.50 div
delta T 0.20 div

**from**

Select **W'form**.

**into**

Select **D=M4** if the mask has to be automatically displayed on the screen, otherwise select **M1** to **M4**. Using the Waveform Recall menu, memories M1 to M4 can be recalled to traces A to D for display (see page 21-1).

**INVERT MASK**

Use this menu button to generate an inverted mask.

**Use W'form**

Select the waveform to be used as a reference. The mask will be generated around this waveform.

**MAKE MASK**

Use this menu button to generate the mask.

**delta V**

Select tolerance in amplitude, using the menu knob attributed to this field.

**delta T**

Select tolerance in time, using the menu knob attributed to this field.

**RECALLING A MASK  
FROM A CARD OR DISK**

MODIFY MASK

from

Card **DISK**

W'form

into

**D=M4**

M1 M2 M3 M4

INVERT MASK

**D=M4**

DO RECALL

SC2.020

File

SC1	020
<b>SC2</b>	<b>020</b>
SC1	021
SC2	021

26-FEB-93  
14:22:26  
Size 47817

from

Select **Card** or **Disk**.

into

Select **D=M4** if the mask has to be automatically displayed on the screen, otherwise select **M1** to **M4**.

**INVERT MASK**

Use this menu button to generate an inverted mask.

**DO RECALL**

Use this menu button to recall the mask.

**File**

Select the appropriate mask, using the menu knob attributed to this field.



**MENU CONTROLS**

**SETTING PASS/FAIL ACTIONS**

CHANGE TEST

On line  
1 2 3 4 5  
**Action**

DELETE ALL ACTIONS

If  
**Pass** Fail

Then:

Stop	Yes
Store	No
<b>Dump</b>	<b>Yes</b>
Beep	No
Pulse	No

Dump  
No **Yes**

Depending on the result of the test – PASSEd or FAILed – certain actions can be taken, as described below.

**on line**  
Select **Action**.

**DELETE ALL ACTIONS**  
Deletes all previously selected actions.

**if**  
The action can be taken if the test PASSEs or FAILs.

**Then:**  
Selects the action to be taken.  
The bottom field enables or disables the action to be taken.

## 23 Panel Setups

### MENU CONTROLS

The Panel Setups menu is used to:

- Save the instrument's configuration (Panel Setup) to a non-volatile memory, to the memory card, or to the floppy disk.
- Recall one of the Panel Setups from a non-volatile memory, from the memory card, or from the floppy disk.

PANEL SETUPS
Recall <b>Save</b>
TO SETUP1
TO SETUP2
TO SETUP3
TO SETUP4
TO CARD
TO DISK

#### Save

Select **Save** in the top menu-field (to recall a setup see next menu).

#### TO SETUP

Use the appropriate button to select one of the four setups available.

#### TO CARD

Use this button to save a setup file to the memory card.

#### TO DISK

Use this button to save a setup file to the floppy disk.

**MENU CONTROLS**

PANEL SETUPS

<b>Recall</b> Save
FROM SETUP1 22-NOV-1993 11:12:22
FROM SETUP2 30-NOV-1993 14:55:10
FROM SETUP3 30-NOV-1993 14:55:16
FROM SETUP4 30-NOV-1993 14:55:19
FROM DEFAULT SETUP
From Card or Disk

**Recall**

Select **Recall** in the top menu-field.

**FROM SETUP...**

Use the appropriate button to select one of the four setups available.

**FROM DEFAULT SETUP**

Use this button to select a factory-defined default setup.

**from Card or Disk**

Use this command to go to the Recall Setups menu to recall a setup file on the card or on the disk (see next menu).

**RECALLING A SETUP FROM  
A CARD OR DISK (OPTIONAL)**

RECALL SETUPS

from  
Card **DISK**

25-FEB-93  
10:25:52  
Size 1907

DO RECALL  
P003.PNL

File  
**P003** PNL

**from**

Select **Card** or **Disk**.

**DO RECALL**

Performs the recall from the selected filename.

**File**

Selects the setup file, using the attributed menu knob.

## 24 Show Status

## MENU CONTROLS

The Show Status menu shows the following summaries of the instrument's status:

- Acquisition
- System
- Waveform text and trigger times
- Waveform

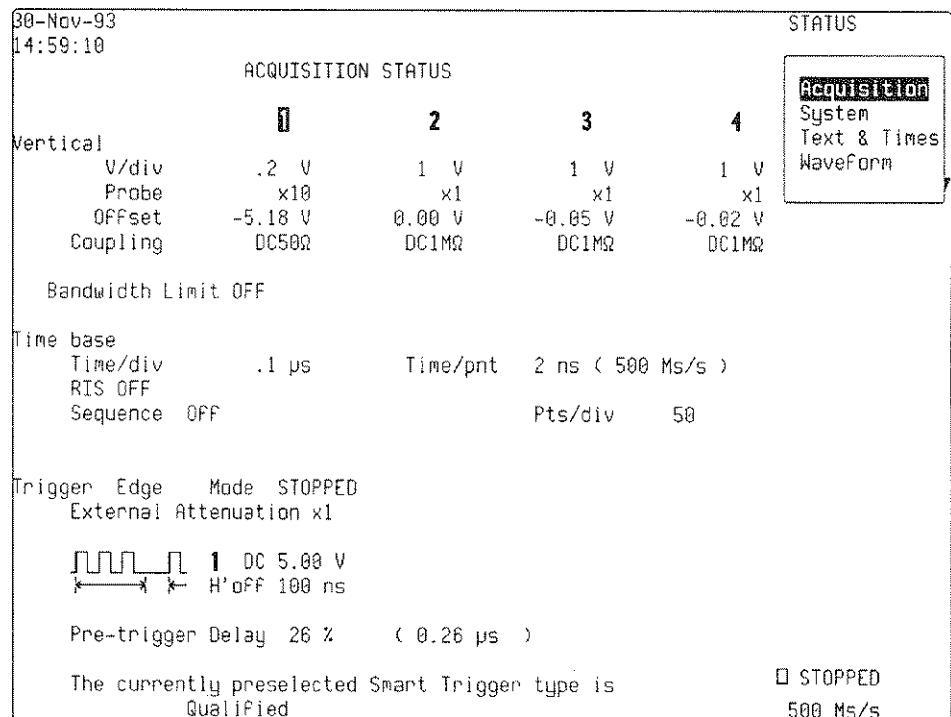

### ACQUISITION SUMMARY

Shows for each channel the vertical sensitivity, probe attenuation, offset and coupling, followed by the timebase, trigger and delay status summaries.

**MENU CONTROLS**

```
7-Dec-93
15:25:11

Serial Number 935401214
Soft Version 9354L 04.0

Soft Options
WP01 WP02 CKIO MC01

Hard Options
GPIB R232 CLBZ F001 GP01 CENT CPU3 I2C

Main RAM size 16 Mbytes

STATUS
Acquisition
System
Text & Times
WaveForm

□ STOPPED
```

**SYSTEM SUMMARY**

Shows the instrument's serial number, the firmware version, and the software or hardware options installed.

**MENU CONTROLS**

30-Nov-93 30° 16:06:37 .0			STATUS
For waveform 1			Acquisition System <b>Text &amp; Times</b> Waveform
Segment	Time	Time since Segment 1	
1)	30-Nov-1993 16:04:47		
2)	30-Nov-1993 16:04:47	500.003 $\mu$ s	
3)	30-Nov-1993 16:04:47	1.000006 ms	
4)	30-Nov-1993 16:04:47	1.500009 ms	
5)	30-Nov-1993 16:04:47	2.000012 ms	
6)	30-Nov-1993 16:04:47	2.500015 ms	
7)	30-Nov-1993 16:04:47	3.000018 ms	
8)	30-Nov-1993 16:04:47	3.500021 ms	
9)	30-Nov-1993 16:04:47	4.000024 ms	
10)	30-Nov-1993 16:04:47	4.500027 ms	
11)	30-Nov-1993 16:04:47	5.000030 ms	
12)	30-Nov-1993 16:04:47	5.500033 ms	
13)	30-Nov-1993 16:04:47	6.000036 ms	
14)	30-Nov-1993 16:04:47	6.500039 ms	
15)	30-Nov-1993 16:04:47	7.000042 ms	
16)	30-Nov-1993 16:04:47	7.500045 ms	
17)	30-Nov-1993 16:04:47	8.000048 ms	
18)	Not acquired		
19)	Not acquired		
20)	Not acquired		
			For <input type="checkbox"/> 2 <input type="checkbox"/> 3 <input type="checkbox"/> 4 A B C D M1 M2 M3 M4
			<input type="checkbox"/> STOPPED 1 Gs/s

**TEXT & TIMES SUMMARY**

Shows the user text in the waveform descriptor (see Remote Control Manual), together with the trigger timing information.

**MENU CONTROLS**

30-Nov-93 30° 16:09:52 .0 WAVEFORM	1	2	3	4	STATUS
Trigger date	30-Nov-1993	30-Nov-1993	30-Nov-1993	30-Nov-1993	Acquisition System Text & Times WaveForm
time	16:04:47	16:04:47	16:04:47	16:04:47	
for	0.01 s	0.01 s	0.01 s	0.01 s	
Vertical					
Scale/div	5.0 V	200 mV	50 mV	1.00 V	Channels Zoom+Math Memories Displayed
Offset	0.1 V	-442 mV	0 mV	0.84 V	
Coupling	AC1MΩ	DC1MΩ	AC1MΩ	DC1MΩ	
BW-Limit	OFF	OFF	OFF	OFF	
Horizontal					
Scale/div	1.0 μs	1.0 μs	1.0 μs	1.0 μs	Channels Zoom+Math Memories Displayed
Offset	10.0 % Pre	10.0 % Pre	10.0 % Pre	10.0 % Pre	
Scale/pnt	1.0 ns	1.0 ns	1.0 ns	1.0 ns	
Pnts/div	1000	1000	1000	1000	
Record Type	SINGLE	SINGLE	SINGLE	SINGLE	
Segments	17( 20)	17( 20)	17( 20)	17( 20)	
Sweeps					
					<input type="checkbox"/> STOPPED 1 Gs/s

**WAVEFORM SUMMARY**

Shows detailed status information on channels, zoom + math traces, memories, or the displayed traces. Use the bottom menu box to select the desired summary.



**MENU CONTROLS**

28-Feb-94  
16:08:23

STATUS

Acquisition System  
Text & Times  
Waveform  
**Memory Used**

Memory used for storage of records

<b>A</b>	1 000 028	bytes
<b>B</b>	1 000 028	bytes
<b>C</b>	1 000 028	bytes
<b>D</b>	1 000 028	bytes
<b>M1</b>	1 000 028	bytes
<b>M3</b>	1 000 028	bytes
Free	9 579 964	bytes
Total	15 580 132	bytes

**CLEAR M1**

**M2 empty**

**CLEAR M3**

**M4 empty**

To free some memory, you can

- . clear Memory waveforms
- . reduce the number of points used for Math (MATH SETUP)
- . reduce the number of samples in the Record (TIMEBASE SETUP)
- . turn off traces or parameters

AUTO  
500 MS/s

**MEMORY USED SUMMARY** Shows memory allocation. Memories M1 to M4 can be cleared using this menu.

## Specifications

## APPENDIX A

### VERTICAL ANALOG SECTION

#### Bandwidth (– 3 dB)

@ 50  $\Omega$ : DC to 500 MHz  
below 200 mV/div: DC to 400 MHz  
@ 1 M $\Omega$ : DC to 250 MHz typical, at probe tip.

**Input impedance:** 1 M $\Omega$  // 15 pF and 50  $\Omega$   $\pm$  1%.

**Sensitivity range:** 2 mV/div to 5 V/div, continuously variable. Fixed settings range from 2 mV/div to 5 V/div in a 1, 2, 5 sequence.

**Vertical expansion:** up to 5 times (with averaging, up to 50 times or 40  $\mu$ V/div sensitivity).

**Scale factors:** Probe attenuation factors of x1, x2, x5, x10, x20, x25, x50, x100, x200, x500, x1000 or x10000 may be selected.

**Offset:**

2 – 9.9 mV/div	$\pm$ 120 mV
10 – 199 mV/div	$\pm$ 1.2 V
0.2 V – 5 V/div	$\pm$ 24 V

**DC accuracy:**  $\leq$   $\pm$ 2%.

**Bandwidth limiter:** 30 MHz (– 3 dB) typical.

**Max input voltage:** 250 V (DC + peak AC  $\leq$  10 kHz) at 1 M $\Omega$ ,  $\pm$  5 V DC (500 mW) or 5 V RMS at 50  $\Omega$ .

### VERTICAL DIGITAL SECTION

**ADCs:** One per channel, 8-bit flash.

#### Maximum sampling rate:

	9350	9354
1 channel	1 GS/s	2 GS/s
2 channels	500 MS/s	1 GS/s
4 channels	N/A	500 MS/s

**Aperture uncertainty:**  $\pm$ 10 ps.

#### Acquisition memory segmentation:

number of segments		
9350/54L	9350/54M	9350/54
2-2000	2-200	2-50

**Acquisition memories:** (8-bit): 25K (100K on M models and 2M on L models).

## APPENDIX A

**Reference memories (16-bit):** Four reference memories (M1, M2, M3, M4).

**Waveform processing memories (16-bit):** Four waveform processing traces (A, B, C, D).

### HORIZONTAL SECTION

#### Time Base

**Range:** 1 ns/div to 1000 s/div.

**Clock accuracy:**  $\leq 3$  ppm

**Interpolator resolution:** 10 ps.

**Interpolator accuracy:** 20 ps RMS

#### Acquisition Modes

**Random Interleaved Sampling (RIS)** for repetitive signals from 1 ns/div to 5  $\mu$ s/div.

**Single shot** for transient signals and repetitive signals from 10 ns/div to 1000 s/div.

**Peak Detect** captures and displays 2.5 ns glitches or other high-speed events.

**Sequence:** Stores multiple events in segmented acquisition memories (see acquisition memory segmentation above).

#### Trigger

**Pre-trigger recording:** Adjustable in 1% increments to 100% of full scale (grid width).

**Post-trigger delay:** Adjustable in 0.1 division increments up to 10,000 divisions.

**External trigger input:** 1 M $\Omega$ , < 15pF, 250 V max. (DC + peak AC  $\leq 10$  kHz).

**External trigger range:**  $\pm 2$  V in Ext,  $\pm 20$  V in Ext/10.

**Rate:** Up to 500 MHz using HF trigger coupling.

**Timing:** Trigger timing (date and time) is listed in the memory status menu. The timing of subsequent triggers in sequence mode is measured with 1 s absolute resolution, or nanosecond resolution relative to the time of the first trigger.

#### Standard Trigger

**Sources:** Chan1, Chan2, (Chan3 and Chan4 for 4-channel models), Line, Ext, Ext/10. Slope, coupling and level can be set individually for each source.

**Slope:** Positive, negative.

**Coupling:** HF, AC, LF REJ, HF REJ, DC.

**Hold-off by time:** 25 ns to 20 s.

**Hold-off by events:** 0 to 1,000,000,000 events.

#### SMART Trigger

**Pulse Width:** Trigger on pulse widths within or outside of time limits selectable between 2.5 ns and 20 s.

**Interval Width:** Trigger on pulse distances within or outside of two time limits selectable between 2.5 ns and 20 s.

**Pattern:** Triggers on the logical AND of Chan1, Chan2, Chan3, Chan4 and EXT where each source can be defined as high (H), low (L), or don't care (X). Hold-off by time or events is as described above.

**Dropout:** Trigger whenever the input signal drops out for longer than a selectable timeout.

**State/Edge qualified:** Trigger on any source only if a given state (or transition) has occurred on one of the other possible sources. From the time of occurrence of the latter, a delay can be defined in terms of time or number of events on the trigger channel. Alternatively, a trigger is accepted within a time window which starts at the transition of one of the other trigger sources.

**TV:** Allows stable triggering on TV signals that comply with PAL, SECAM or NTSC standards. Selection on both line (up to 1500) and field number (up to 8) is possible.

#### DISPLAY

**CRT:** 12.5 × 17.5 cm (5 × 7 inches); magnetic deflection; raster type.

**Resolution:** 810 × 696 points.

**Real-time clock:** Date, hours, minutes, seconds.

**Grid:** Internally generated; separate intensity control for grid and waveforms. Single, dual and quad grid modes.

**Hard copy:** HP QuietJet, ThinkJet, LaserJet, PaintJet, DeskJet and EPSON printers, as well as HP7470 and HP7550 plotters or compatible instruments, can be used to make hard copies of the display. The TIFF graphics format is also supported in order to incorporate the oscilloscope screens in word processing or desktop publishing.

## APPENDIX A

---

software packages. Screen dumps are activated by a front-panel button or via remote control.

**XY mode:** Displays pairs of data points of any two sources (Channels or Traces A, B, C, D). Can be combined with persistence.

Grids can be chosen for XY only or XY plus normal waveform display of sources in a common grid or separately.

Time and XY voltage cursors are available.

**Persistence mode:** Displays consecutively acquired traces on top of each other, allowing waveform trends to be examined. Simultaneous display of normal trace is superimposed.

Time and XY voltage cursors are available.

### Cursors

**Relative time:** Two cursors provide time measurements with a resolution of  $\pm 0.05\%$  of full scale for unexpanded traces; up to  $\pm 10\%$  of the data point sampling interval for expanded traces. The corresponding frequency information is also provided.

**Relative voltage:** Two horizontal bars measure voltage differences up to  $\pm 0.2\%$  of full scale for each trace in single grid mode.

**Absolute time:** A cross-hair marker measures time relative to the trigger as well as absolute voltage versus signal ground.

**Absolute voltage:** A reference bar measures absolute voltage with respect to ground.

**Pulse parameters:** Two cross-hair cursors are used to define a region of interest for which pulse parameters will be calculated automatically.

### AUTO-SETUP

Pressing the auto-setup button automatically scales the timebase, trigger and sensitivity settings to display a wide range of repetitive input signals.

**Type of signals detected:** Repetitive signals with amplitudes between 2 mV and 40 V, frequency above 50 Hz and a duty cycle greater than 0.1%.

**Auto-setup time:** Approximately 2 seconds.

### Vertical find

Automatically scales sensitivity and offset.

**WAVEFORM PROCESSING**

Waveform processing routines are called and set up via menus. These include arithmetic functions (add, subtract, multiply, divide, negate, identity), and summation averaging (up to 1000 signals).

**Pulse parameters:** Based on ANSI/IEEE Std 181-1977 "Standard on Pulse Measurement and Analysis by Objective Techniques". The terminology is derived from IEEE Std 194-1977 "Standard Pulse Terms and Definitions".

**Automatic measurements determine:**

amplitude	mean
area	median
base	minimum
cycles	overshoot negative
delay	overshoot positive
$\Delta$ delay	peak-peak
$\Delta t$ at level	period
duty cycle	points
falltime	risetime
fall 80-20%	rise 20-80%
fall at level	rise at level
first	root mean square
frequency	standard deviation
last	top
maximum	width

Statistics can be performed on each of the automatic measurements, showing the following statistical information:

- Average
- High
- Low
- Standard Deviation

Automatic PASS/FAIL allows up to five waveform parameters to be tested against selectable thresholds. Waveforms may also be tested against a tolerance template which can be generated inside the instrument.

**Optional Processing**

Extra processing power can be added by installing LeCroy's waveform processing options. Option WP01 provides waveform characterization in high resolution mode up to 11 bits, and extended mathematical analysis (integration, differentiation, etc.), as well as

## APPENDIX A

	<p>averaging and extrema mode for the accumulation of maximum and minimum values. Option WP02 performs spectral analysis (FFT processing).</p>
<b>HARDWARE OPTIONS</b>	<p>GP01: Internal printer + Centronics interface. Roster printer, thermal, resolution 190 DP1. Printout size: 126 × 90 mm.</p> <p>FD01: 3.5, floppy drive + Centronics interface. DOS format, supports 1.44 Mb and 720 Kb densities.</p> <p>MC01/04: PCMIA 1.0 memory card reader + 512k memory card.</p>
<b>REMOTE CONTROL</b>	<p>Front-panel controls, including variable gain, offset, position controls and cursors, as well as all internal functions, are programmable.</p> <p><b>RS-232-C port:</b> For computer/terminal control or plotter connection. Asynchronous up to 19200 baud.</p> <p><b>GPIB port:</b> (IEEE-488). Configured as talker/listener for computer control and fast data transfer.</p> <p><b>Local/remote:</b> Remote control can be interrupted for local (manual) control at any time (except when in remote control with the lock-out state selected) by pushing a button on the front panel.</p>
<b>PROBES</b>	<p>One PP002 (×10, 10 MΩ // 15 pF) probe supplied per channel.</p> <p><b>Probe calibration:</b> 250 mV into 50 Ω, frequency-programmable square wave, rise-time &lt; 750 ps, fall-time &lt; 500 ps, flatness within 1%.</p>
<b>GENERAL</b>	<p><b>Temperature:</b> 5° to 40° C (41° to 104° F) rated; 0° to 50° C (32° to 122° F) operating.</p> <p><b>Humidity:</b> &lt; 80%.</p> <p><b>Power required:</b> 90 – 250 V AC, 45 to 66 Hz, 230 W.</p> <p><b>Shock and vibration:</b> Meets requirements of MIL-STD-810C modified to LeCroy design specifications, and MIL-T-28800C.</p> <p><b>Battery backup:</b> Accumulators maintain front-panel settings for two years.</p> <p><b>Dimensions:</b> (HWD) 21 × 37 × 41cm (8½ × 14½ × 16¼ inches).</p> <p><b>Weight:</b> 10kg (22lbs) net, 15.5kg (34lbs) shipping.</p> <p><b>Warranty:</b> two years.</p>

**ENHANCED RESOLUTION**

Quite often the high sampling rate available in LeCroy oscilloscopes is higher than is actually required for the bandwidth of the signal being analyzed. This oversampling, facilitated by the oscilloscope's long memories, can be used to advantage by filtering the digitized signal in order to increase the effective resolution of the displayed trace. This is similar to smoothing the signal with a simple moving average filter, except that it is more efficient in terms of bandwidth, and has better passband characteristics. It can be used instead of averaging successive traces for waveforms with single-shot characteristics.

**Advantages of  
Enhanced Resolution**

Two subtly different characteristics of the instrument are improved by the enhanced resolution filtering:

1. In all cases the resolution (i.e. the ability to distinguish closely-spaced voltage levels) is improved by a fixed amount for each filter. This is a true increase in resolution which occurs whether or not the signal is noisy, and whether or not it is a single-shot or a repetitive signal.
2. The signal-to-noise ratio (SNR) is improved in a manner which depends on the form of the noise in the original signal. This occurs because the enhanced resolution filtering decreases the bandwidth of the signal, and will therefore filter out some of the noise.

**Implementation**

The oscilloscope implements a set of linear phase finite impulse response (FIR) filters, optimised to provide fast computation, excellent step response and minimum bandwidth reduction for resolution improvements of between 0.5 and 3 bits in 0.5 bit steps. Each 0.5 bit step corresponds to a bandwidth reduction by a factor of two, allowing easy control of the bandwidth/resolution trade-off. The parameters of the six filters are given in the following table:



**APPENDIX B**

<b>Resolution Increase (Enhancement)</b>	<b>-3 dB Bandwidth (× Nyquist)</b>	<b>Filter Length (samples)</b>
0.5	0.5	2
1.0	0.241	5
1.5	0.121	10
2.0	0.058	24
2.5	0.029	51
3.0	0.016	117
<b>Parameters of the FIR Enhanced Resolution Filters</b>		

The filters used are low-pass filters, so the actual increase in SNR obtained in any particular situation will depend on the power spectral density of the noise present on the signal. The improvement in SNR corresponds to the improvement in resolution if the noise in the signal is white, i.e. evenly distributed across the frequency spectrum. If the noise power is biased towards high frequencies then the SNR improvement will be better than the resolution improvement. Whereas if the noise is mostly at lower frequencies, the improvement may not be as good as the resolution improvement. The improvement in the SNR due to the removal of coherent noise signals (for example, feed-through of clock signals) depends on whether the dominant frequency components of the signal fall in the passband of the filter or not. This can easily be deduced by using the spectrum analysis option (WP02) of the oscilloscope.

The filters used for the enhanced resolution function have an exactly linear phase response. This has two desirable properties. Firstly, the filters do not distort the relative position of different events in the waveform even if the frequency content of the events is different. Secondly, by also using the fact that the waveforms are stored, the delay normally associated with filtering (between the input and output waveforms) can be exactly compensated for during the computation of the filtered waveform.

All filters have been implemented to have exactly unity gain (at low frequency). Therefore, enhanced resolution should not cause overflow if the source data were not overflowed. If part of the source trace had overflowed, filtering will be allowed, but it must be remembered that the results in the vicinity (within the length of the filter impulse response) of the overflowed data will be incorrect. This is permitted because in some circumstances an overflow may be a spike of only one or two samples. The energy in this spike might not be sufficient to significantly affect the results, so it would be undesirable to disallow the whole trace in this case.

#### **When should Enhanced Resolution be used?**

There are two main situations for which enhanced resolution is especially useful. Firstly, if the signal is noticeably noisy (and measurements of the noise are not required), the signal can be "cleaned up" by using the enhanced resolution function. Secondly, even if the signal is not particularly noisy, but high precision measurements of the waveform are required (perhaps when using Expand with high vertical gain) then enhanced resolution will increase the resolution of the measurements.

In general, enhanced resolution replaces the averaging function in situations where the data record has a single-shot or slowly repetitive nature and averaging cannot be used.

The following examples illustrate uses of the enhanced resolution function in these situations.

**APPENDIX B**

**Low-pass filtering**

The figure below shows the spectrum of a square signal before (top grid) and after (bottom grid) enhanced resolution processing. The result clearly shows how the filter rejects high-frequency components from the signal. The higher the bit enhancement, the lower the resulting bandwidth.

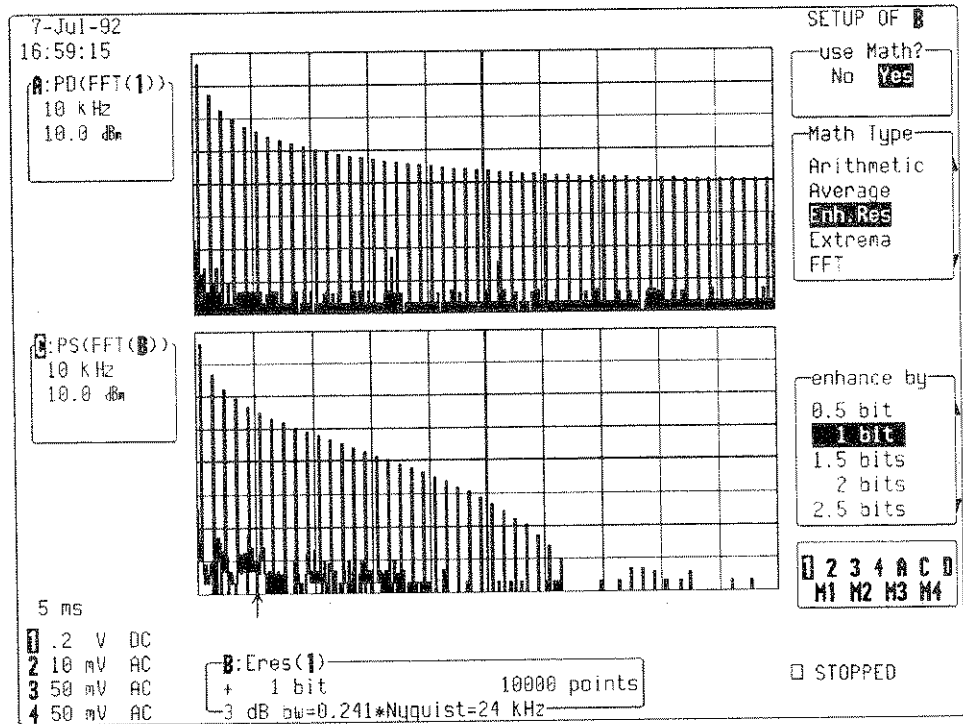

**Increasing Vertical Resolution**

In the following example the bottom trace has been significantly enhanced by a 3-bit enhanced resolution function.

*Note: The original signal being highly over-sampled, the resulting bandwidth is still high enough for the signal not to be distorted.*

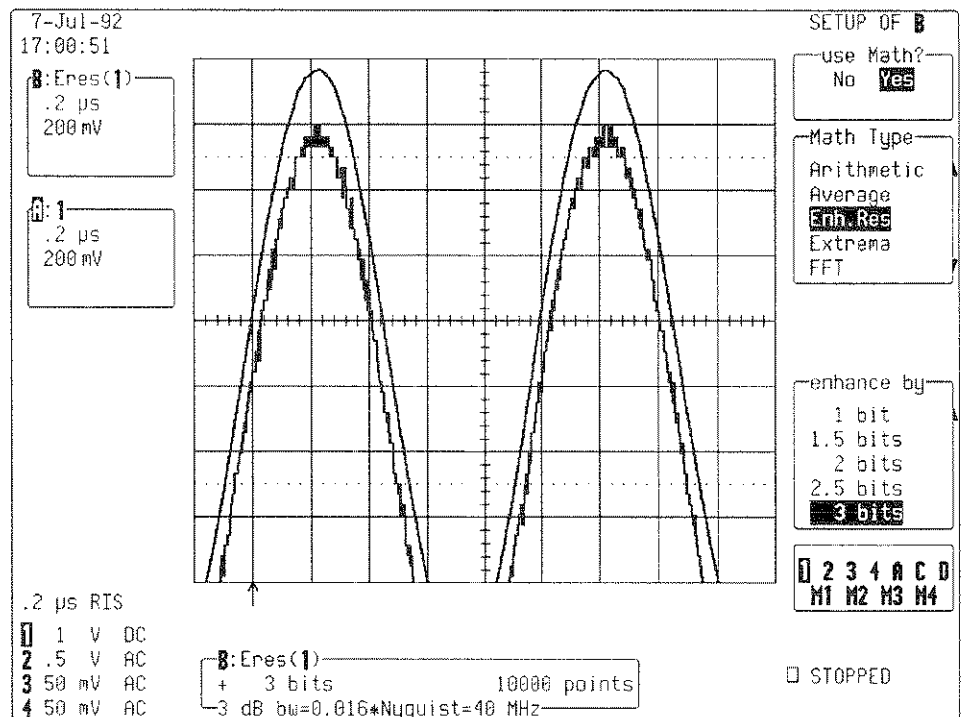

**APPENDIX B**

**Reducing Noise**

The following figure shows the effect of enhanced resolution on a noisy signal.

The original trace (top grid) has been processed by a 2-bit enhanced resolution filter.

The result (bottom grid) shows a "smooth" trace where most of the noise has been eliminated.

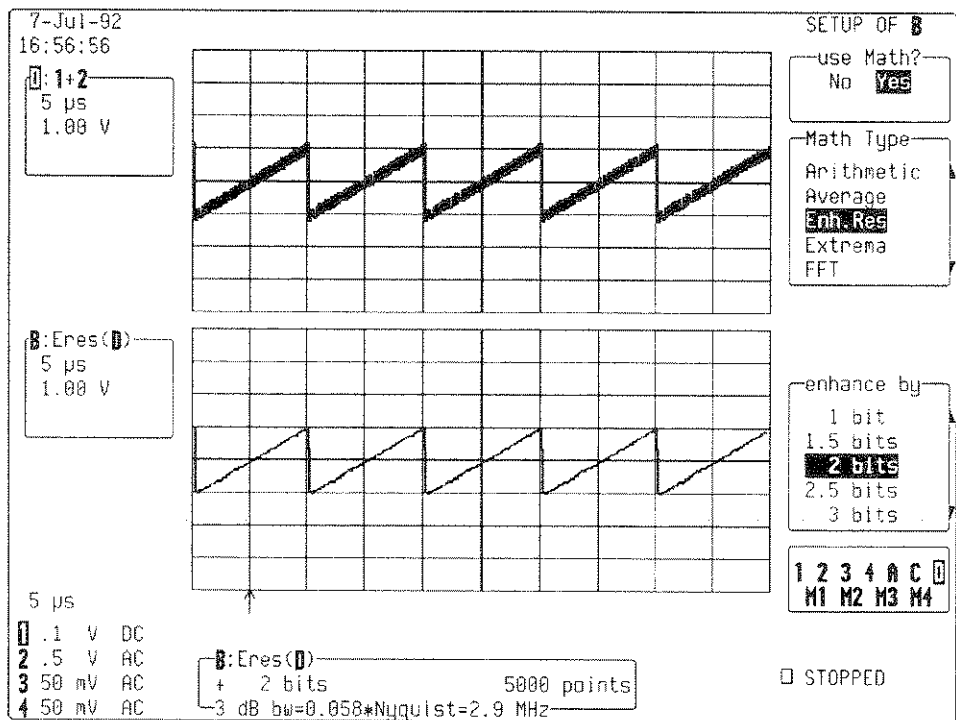

## Cautionary notes

The enhanced resolution function only improves the resolution of a trace, it cannot improve the accuracy or linearity of the original quantization by the 8-bit ADC.

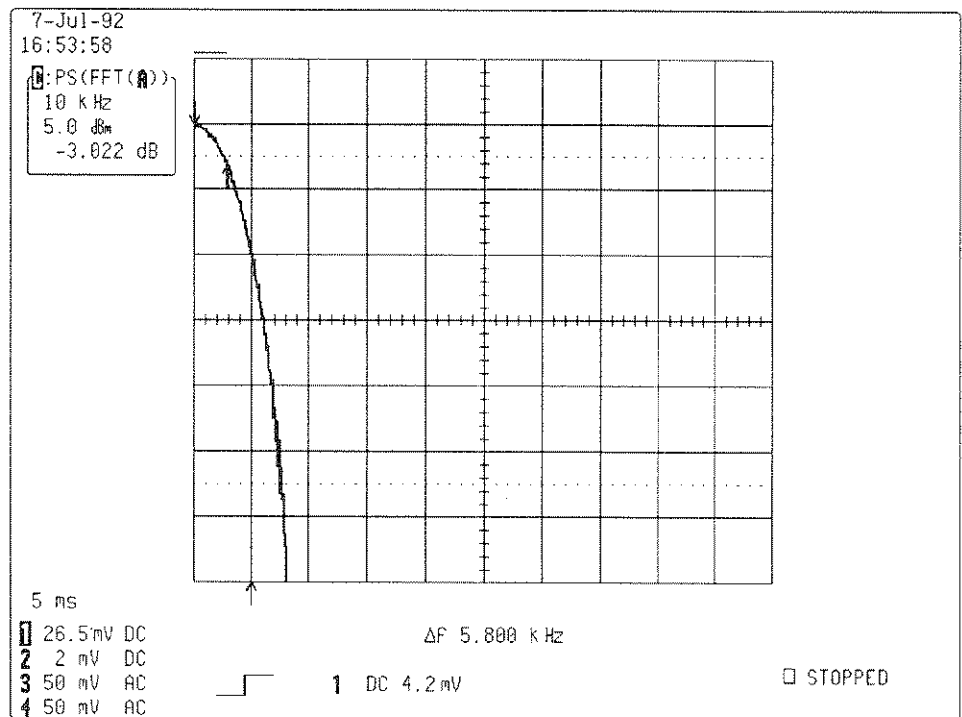

The constraint of good temporal response for the enhanced resolution filters excludes the use of maximally-flat filters. Therefore, the passband will cause slight signal attenuation for signals near the cut-off frequency. One must be aware when using these filters that the highest frequencies passed may be slightly attenuated. The frequency response of a typical enhanced resolution filter (the 2-bit enhancement filter) is shown in the above figure. The  $-3$  dB cut-off frequency at 5.8% of the Nyquist frequency is marked.

The filtering must be performed on finite record lengths, therefore the discontinuities at the ends of the record cause data to be corrupted at these points. These data points are not displayed by the oscilloscope and so the trace becomes slightly shorter after filtering.

## APPENDIX B

---

The number of samples lost is exactly equal to the length of the impulse response of the filter used, and thus varies between 2 and 117 samples. Because the oscilloscope has very long waveform memories this loss is not normally noticed (it is only 0.2% of a 50,000 point trace). However, it is possible to ask for filtering on a record so short that there would be no data output. The oscilloscope will not allow filtering in this case.

The FFT option (WP02) adds the spectrum analysis capability to the oscilloscope. This appendix gives additional information on its use.

Spectra of single time-domain waveforms can be computed and displayed and Power Averages can be obtained over as many as 50000 spectra.

Spectra are displayed with a linear frequency axis running from zero to the Nyquist frequency. The frequency scale factors (Hz/div) are in a 1-2-5 sequence. The Nyquist frequency is at the right-hand edge of the trace.

The processing equation is displayed at the bottom of the Fourier Transform menu, together with three key parameters which characterize an FFT spectrum:

- 1) Transform Size N (number of input points)
- 2) Nyquist frequency
- 3)  $\Delta f$  (the frequency increment) between two successive points of the spectrum. These parameters are related as follows:

$$\text{Nyquist frequency} = \Delta f * N/2$$

Also note that  $\Delta f = 1/T$ , where T is the duration of the input waveform record (10 \* time/div).

The number of output points is equal to N/2.

The menu allows the user to set the following parameters:

#### Type

**Power Spectrum** (dBm) is the signal power (or magnitude) represented on a logarithmic vertical scale. 0 dBm corresponds to the voltage (0.316 V peak) which is equivalent to 1 mW into 50  $\Omega$ . The power spectrum is suitable for characterizing spectra which contain isolated peaks.

**Power Density** (dBm) is the signal power normalized to the bandwidth of the equivalent filter associated with the FFT calculation. The power density is suitable for characterizing broad-band noise.

**Magnitude** (same units as the input signal) is the peak signal amplitude represented on a linear scale.

**Phase** (degrees) is measured with respect to a cosine whose maximum occurs at the left-hand edge of the screen, at which point



## APPENDIX C

it has  $0^\circ$ ; similarly, a positive-going sine starting at the left-hand edge of the screen has  $-90^\circ$  phase.

**Real**, **Imaginary** and **Real + Imaginary** (same units as the input signal) represent the complex result of the FFT processing.

### Maximum Number of Points

FFT spectra are computed over all of the source time-domain waveform. This parameter limits the number of points used for FFT processing. If the input waveform contains more points than the selected maximum, these are decimated prior to FFT processing. If the input waveform has fewer points, all points are used.

### Window Type

The window type defines the bandwidth and shape of the equivalent filter associated with the FFT processing.

The **Rectangular** window is normally used when:

- a) the signal is a transient which is completely contained in the time-domain window.
- b) the signal is known to have a fundamental frequency component which is an integer multiple of the fundamental frequency of the window.

Signals not in this class show varying amounts of spectral leakage and scallop loss, which can be corrected by using one of the other windows.

The popular **Von Hann (Hanning)** and **Hamming** windows reduce leakage and improve amplitude accuracy. However, the frequency resolution is also reduced.

The **Flat Top** window provides excellent amplitude accuracy, with moderate reduction of leakage, at the cost of frequency resolution.

The **Blackman-Harris** window reduces the leakage to a minimum, with a trade-off in frequency resolution.

The table in the FFT glossary in this section shows the parameters of equivalent filters.

### FFT POWER AVERAGE

A function can be defined as the **Power Average** of FFT spectra computed by another function.

## PROCESSING FACILITIES

Other waveform processing functions such as Averaging and Arithmetic can be applied to waveforms before the FFT processing. Time-domain averaging prior to FFT can be used if a stable trigger is available. It will reduce the random noise in the signal.

The FFT frequency range (i.e. Nyquist frequency) and the frequency resolution can be controlled as follows:

- To increase the frequency resolution, increase the length of the time-domain waveform record (i.e. use a slower time base).
- To increase the frequency range, increase the effective sampling frequency (i.e. increase the **maximum number of points** or use a faster time base).

The **Memory Status** menu displays parameters of the waveform descriptor (number of points, horizontal and vertical scale factors and units, etc.).

## CURSORS

To read the amplitude and frequency of a data point, the **Absolute Time** cursor can be moved over into the frequency domain by going beyond the right-hand edge of a time-domain waveform.

The **Relative Time** cursors can be moved over into the frequency domain to simultaneously indicate the frequency difference and the amplitude difference between two points on each frequency-domain trace.

The **Absolute Voltage** cursor reads the absolute value of a point in a spectrum in the appropriate units, and the **Relative Voltage** cursors indicate the difference between two levels on each trace.

## FFT ALGORITHMS

A summary of algorithms used in the oscilloscope's FFT computation is given for reference.

- 1) If the maximum number of points is smaller than the source number of points, the source waveform data are decimated prior to the FFT. The decimated data cover the full length of the source waveform.

The resulting sampling interval and the actual transform size selected provide the frequency scale factor in a 1–2–5 sequence.

- 2) The data are multiplied by the selected window function.

## APPENDIX C

- 3) FFT is computed, using a fast implementation of the DFT (Discrete Fourier Transform):

$$X_n = \frac{1}{N} \sum_{k=0}^{k=N-1} x_k \times W^{n \times k}$$

where  $x_k$  is a complex array whose real part is the modified source time-domain waveform, and whose imaginary part is 0.

$X_n$  is the resulting complex frequency-domain waveform.

$$W = e^{(-j \times 2 \times \pi / N)}$$

$N$  is the number of points in  $x_k$  and  $X_n$ .

The generalized FFT algorithm, as implemented here, works on  $N$  which need not be a power of 2.

- 4) The resulting complex vector  $X_n$  is divided by the coherent gain of the window function, to compensate for the loss of the signal energy due to windowing. This compensation provides accurate amplitude values for isolated spectrum peaks.
- 5) The real part of  $X_n$  is symmetric around the Nyquist frequency, that is:

$$R_n = R_{N-n}$$

while the imaginary part is asymmetric, that is:

$$I_n = -I_{N-n}$$

The energy of the signal at a frequency  $n$  is distributed equally between the first and the second halves of the spectrum; the energy at frequency 0 is completely contained in the 0 term.

The first half of the spectrum (Re, Im), from 0 to the Nyquist frequency is kept for further processing and doubled in amplitude:

$$R'_n = 2 \times R_n \quad 0 \leq n < N/2$$

$$I'_n = 2 \times I_n \quad 0 \leq n < N/2$$

- 6) The resultant waveform is computed for the spectrum type selected.

If **Real**, **Imaginary** or both are selected, no further computation is needed. The appropriate part of the complex result is given as the result ( $R'_n$  or  $I'_n$  or  $R'_n + jI'_n$ , as defined above).

If **Magnitude** is selected, the magnitude of the complex vector is computed as:

$$M_n = \sqrt{R_n^2 + I_n^2}$$

Steps (1) to (6) above lead to the following result:

An AC sine wave of amplitude 1.0 V with an integral number of periods  $N_p$  in the time window, transformed with the rectangular window, results in a fundamental peak of 1.0 V magnitude in the spectrum at frequency  $N_p \times \Delta f$ .

However, a DC component of 1.0 V, transformed with the rectangular window, results in a peak of 2.0 V magnitude at 0 Hz.

The waveforms for the other available spectrum types are computed as follows:

Phase: angle =  $\arctan(I_n/R_n)M_n > M_{min}$

angle = 0  $M_n \leq M_{min}$

where  $M_{min}$  is the minimum magnitude, fixed at about 0.001 of the full scale at any gain setting, below which the angle is not well defined.

*dBm Power Spectrum:*

$$dBm PS = 10 \times \log_{10} \left( \frac{M_n^2}{M_{ref}^2} \right) = 20 \times \log_{10} \left( \frac{M_n}{M_{ref}} \right)$$

where  $M_{ref} = 0.316$  V (that is, 0 dBm is defined as a sine wave of 0.316 V peak or 0.224 V RMS, giving 1.0 mW into 50  $\Omega$ ).

The "dBm Power Spectrum" is the same as "dBm Magnitude", as suggested by the above formula.

## APPENDIX C

---

*dBm* Power Density:

$$dBm PD = dBm PS - 10 \times \log_{10} (ENBW \times \Delta f)$$

where ENBW is the equivalent noise bandwidth of the filter corresponding to the selected window  
 $\Delta f$  is the current frequency resolution (bin width)

- 7) The FFT Power Average takes the complex frequency-domain data  $R'_n$  and  $I'_n$  for each spectrum generated in step (5) above, and computes the square of the magnitude

$$M_n^2 = R_n'^2 + I_n'^2,$$

sums  $M_n^2$  and counts the accumulated spectra. The total is normalized by the number of spectra and converted to the selected result type using the same formulae as are used for the Fourier Transform.

EXAMPLES OF FFT PROCESSING

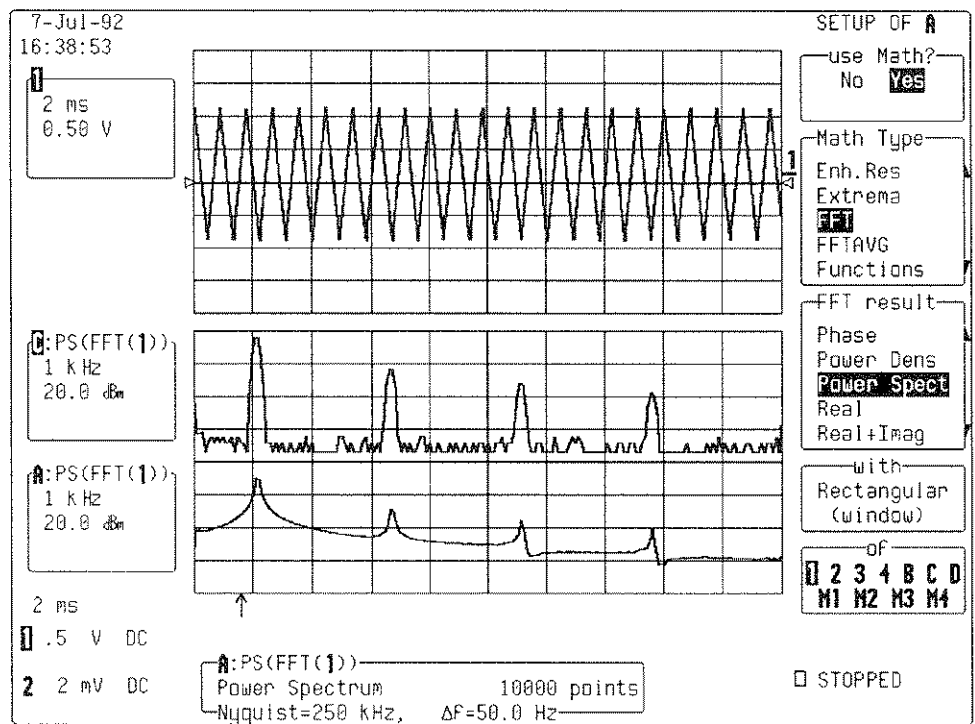

The Effect of Windowing

The figure above illustrates an example with spectral leakage and the use of an appropriate window to reduce the leakage.

Channel 1 (top trace) shows a triangular wave, approximately 1 kHz frequency.

The bottom trace is an expansion of an FFT with a **Rectangular** window. Each peak, and especially the fundamental component at 1 kHz, influences the spectrum over a wide range of frequencies due to the leakage of the signal power through the side lobes of the equivalent filter.

The middle trace is an expansion of another FFT of the same Channel 1 waveform, defined with the **Blackman-Harris** window. The leakage is clearly reduced, but the peaks around the harmonics

**APPENDIX C**

are wider. This reflects the increased bandwidth of the filter associated with the Blackman-Harris window.

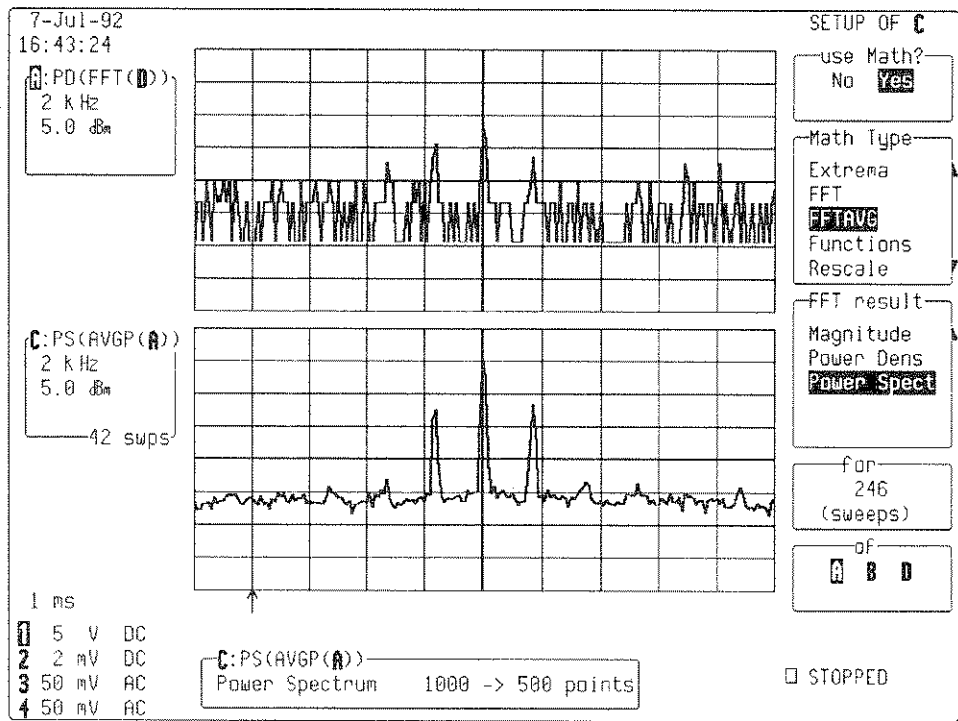

**The Effect of FFT Averaging**

The above figure shows an FFT of a noisy signal (top trace). By applying a power average to this FFT, all the incoherent noise is eliminated. The signal (Amplitude Modulation) is now clearly visible.

**FFT GLOSSARY**

This glossary defines terms frequently used in FFT spectrum analysis and relates them to the oscilloscope.

**Aliasing**

If the input signal to a sampling acquisition system contains components whose frequency is greater than the Nyquist frequency (half the sampling frequency), there will be less than two samples per signal period. The result is that the contribution of these components to the sampled waveform will be indistinguishable from that of components below the Nyquist frequency. This is called aliasing.

The user should select the time base and transform size resulting in a Nyquist frequency higher than the highest significant component in the time-domain record.

**Coherent Gain**

The normalized coherent gain of a filter corresponding to each window function is 1.0 (0 dB) for a rectangular window and less than 1.0 for other windows. It defines the loss of signal energy due to the multiplication by the window function. In the oscilloscope this loss is compensated. The table below lists the values for the windows implemented.

**ENBW (Equivalent Noise Bandwidth)**

For a filter associated with each frequency bin, ENBW is the bandwidth of an equivalent rectangular filter (having the same gain at the center frequency) which would collect the same power from a white noise signal. In the table below, ENBW is listed for each window function implemented and is given in bins.

Window type	Highest side lobe (dB)	Scallop loss (dB)	ENBW (bins)	Coherent gain (dB)
Rectangular	- 13	3.92	1.0	0.0
von Hann	- 32	1.42	1.5	- 6.02
Hamming	- 43	1.78	1.37	- 5.35
Flat-Top	- 44	0.01	2.96	- 11.05
Blackman-Harris	- 67	1.13	1.71	- 7.53

**Window Frequency-Domain Parameters**



## APPENDIX C

### Filters

Computing an N-point FFT is equivalent to passing the time-domain input signal through N/2 filters and plotting their outputs against the frequency. The spacing of filters is  $\Delta f = 1/T$  while the bandwidth depends on the window function used (see Frequency bins).

### Frequency bins

The FFT algorithm takes a discrete source waveform, defined over N points, and computes N complex Fourier coefficients, which are interpreted as harmonic components of the input signal.

For a real source waveform (imaginary part equals 0), there are only N/2 independent harmonic components.

An FFT corresponds to analyzing the input signal with a bank of N/2 filters, all having the same shape and width, and centered at N/2 discrete frequencies. Each filter collects the signal energy that falls into the immediate neighborhood of its center frequency, and thus it can be said that there are N/2 "frequency bins".

The distance, in Hz, between the center frequencies of two neighboring bins is always:

$$\Delta f = 1/T$$

where T is the duration of the time-domain record in seconds.

The width of the main lobe of the filter centered at each bin depends on the window function used. The rectangular window has a nominal width at 1.0 bin. Other windows have wider main lobes (see table on page C-9).

### Frequency Range

The range of frequencies computed and displayed is 0 Hz (displayed at the left-hand edge of the screen) to the Nyquist frequency (at the rightmost edge of the trace).

### Frequency Resolution

In a simple sense, the frequency resolution is equal to the bin width,  $\Delta f$ . That is, if the input signal changes its frequency by  $\Delta f$ , the corresponding spectrum peak will be displaced by  $\Delta f$ . For smaller changes of frequency, only the shape of the peak will change.

However, the effective frequency resolution (i.e. the ability to resolve two signals whose frequencies are almost the same) is further limited by the use of window functions. The ENBW value of all windows other than the rectangular is greater than  $\Delta f$ , i.e. greater than the bin width. The table on page C-9 lists the ENBW value for the windows implemented.

**Leakage**

Observe the power spectrum of a sine wave having an integral number of periods in the time window (i.e. the source frequency equals one of the bin frequencies) using a rectangular window. The spectrum contains a sharp component whose value reflects accurately the source waveform's amplitude. For intermediate input frequencies this spectral component has a lower and broader peak.

The broadening of the base of the peak, stretching out into many neighboring bins is termed the leakage. It is due to the relatively high side lobes of the filter associated with each frequency bin.

The filter side lobes and the resulting leakage are reduced when one of the available window functions is applied. The best reduction is provided by the **Blackman-Harris** and the **Flat Top** windows. However, this reduction is offset by a broadening of the main lobe of the filter.

**Numbers of Points**

FFT is computed over the number of points (Transform Size) whose upper bounds are the source number of points and the maximum number of points selected in the menu.

FFT generates spectra having  $N/2$  output points.

**Nyquist Frequency**

The Nyquist frequency is equal to one half of the effective sampling frequency (after the decimation), i.e.  $\Delta f \times N/2$ .

**Picket Fence Effect**

If a sine wave has a whole number of periods in the time domain record, the power spectrum obtained with a rectangular window will have a sharp peak, corresponding exactly to the frequency and amplitude of the sine wave. On the other hand, if a sine wave does not have a whole number of periods in the record, the spectrum peak obtained with a rectangular window will be lower and broader.

The highest point in the power spectrum can be 3.92 dB lower (1.57 times) when the source frequency is halfway between two discrete bin frequencies. This variation of the spectrum magnitude is called the picket fence effect (the loss is called the scallop loss).

All window functions compensate this loss to some extent, but the best compensation is obtained with the Flat Top window (see table on page C-9).

## APPENDIX C

### Power Spectrum

The power spectrum ( $V^2$ ) is the square of the magnitude spectrum. The power spectrum is displayed on the dBm scale, with 0 dBm corresponding to  $V_{ref}^2 = (0.316 V_{peak})^2$ , where  $V_{ref}$  is the peak value of the sinusoidal voltage which is equivalent to 1 mW into 50  $\Omega$ .

### Power Density Spectrum

The power density spectrum ( $V^2/Hz$ ) is the power spectrum divided by the equivalent noise bandwidth of the filter, in Hz.

The power density spectrum is displayed on the dBm scale, with 0 dBm corresponding to ( $V_{ref}^2/Hz$ ).

### Sampling Frequency

The time-domain records are acquired at sampling frequencies which depend on the selected time base.

Before the FFT computation, the time-domain record may be decimated. If the selected maximum number of points is lower than the source number of points, the effective sampling frequency is reduced.

The effective sampling frequency equals twice the Nyquist frequency.

### Scallop Loss

Loss associated with the picket fence effect (listed in the table on page C-9 for windows implemented).

### Window Functions

All available window functions belong to the sum of cosines family with one to three non-zero cosine terms:

$$W_k = \sum_{m=0}^{m=M-1} a_m \cos\left(\frac{2\pi k}{N} m\right) \quad 0 \leq k < N$$

where  $M = 3$  is the maximum number of terms

$a_m$  are the coefficients of the terms

$N$  is the number of points of the decimated source waveform

$k$  is the time index

The table below lists the coefficients  $a_m$ .

The window functions, seen in the time domain are symmetric around the point  $k = N/2$

Window type	a0	a1	a2
Rectangular	1.0	0.0	0.0
von Hann	0.5	-0.5	0.0
Hamming	0.54	-0.46	0.0
Flat-Top	0.281	-0.521	0.198
Blackman-Harris	0.423	-0.497	0.079
<b>Coefficients Of Window Functions</b>			

**ERROR MESSAGES**

For some combinations of source waveform properties and processing functions, one of the following error messages may be displayed at the top of the screen:

**Incompatible input record type**

FFT power average is defined only on a function defined as FFT.

**Horizontal units don't match**

FFT of a frequency-domain waveform is not available.

**FFT source data zero filled**

If there are invalid data points in the source waveform (at the beginning or at the end of the record), these are replaced by zeros before FFT processing.

**FFT source data over/underflow**

The source waveform data has been clipped in amplitude, either in the acquisition (gain too high or inappropriate offset) or in previous processing. The resulting FFT contains harmonic components which would not be present in the unclipped waveform.

The settings defining the acquisition or processing should be changed to eliminate the over/underflow condition.

**Circular computation**

A function definition is circular (i.e. the function is its own source, indirectly via another function or expansion). One of the definitions should be changed.

## APPENDIX C

---

### REFERENCES

**Bergland, G.D.**, "A Guided Tour of the Fast Fourier Transform", IEEE Spectrum, July 1969, pp. 41 – 52.

A general introduction to FFT theory and applications.

**Harris, F.J.**, "On the Use of Windows for Harmonic Analysis with the Discrete Fourier Transform", Proceedings of the IEEE, vol. 66, No. 1, January 1978, pp. 51 – 83.

Classical paper on window functions and their figures of merit, with many examples of windows.

**Brigham, E.O.**, "The Fast Fourier Transform", Prentice Hall, Inc., Englewood Cliffs, N.J., 1974.

Theory, applications and implementation of FFT. Includes discussion of FFT algorithms for N not a power of 2.

**Ramirez, R.W.**, "The FFT Fundamentals and Concepts", Prentice Hall, Inc., Englewood Cliffs, N.J., 1985.

Practice oriented, many examples of applications.

Parameter measurements are based on the recommendations of IEEE Std 181–1977 "Standard on Pulse Measurement and Analysis by Objective Techniques", and terminology is derived from ANSI/IEEE Std 194–1977 "Standard Pulse Terms and Definitions".

### VOLTAGE MEASUREMENTS

In order to find magnitude reference crossings, the base and top magnitudes are assigned. The method employed follows IEEE Std 181–1977. The magnitude histogram of the waveform within the cursor window is created and searched for dominant magnitude populations. If no two dominant populations can be found, the minimum and the maximum of the distribution are used. Of the two magnitudes, the first in the cursor window is assigned to the **Base** line and the other to the **Top** line.

**Amplitude** is measured by the absolute difference between Base and Top.

**Maximum** determines the maximum voltage within the area defined by the cursors.

**Minimum** determines the minimum voltage within the area defined by the cursors.

The following can then be computed:

Peak to Peak value	=	Maximum – Minimum
Overshoot positive	=	(Maximum – higher value of Base and Top – Minimum) / Amplitude
Overshoot negative	=	(Maximum – lower value of Base and Top – Minimum) / Amplitude
Median	=	0.5 (Base + Top)

*Note: In the following,  $v_i$  denotes the measured sample values. The number of data values used for computing Mean, Standard Deviation, RMS, and Area values depends on the identification of a periodic waveform. If one or more periods are identified, a sub-window is used which starts at the first mesial point (50% magnitude transition) and ends at the last mesial point on a leading edge in the original window (i.e. in the formulae below,  $N$  = the number of data points within the periods found up to a maximum of 100 periods). In all other cases, Mean, Standard Deviation, RMS, and Area are evaluated using all data points inside the cursor window.*

**APPENDIX D**

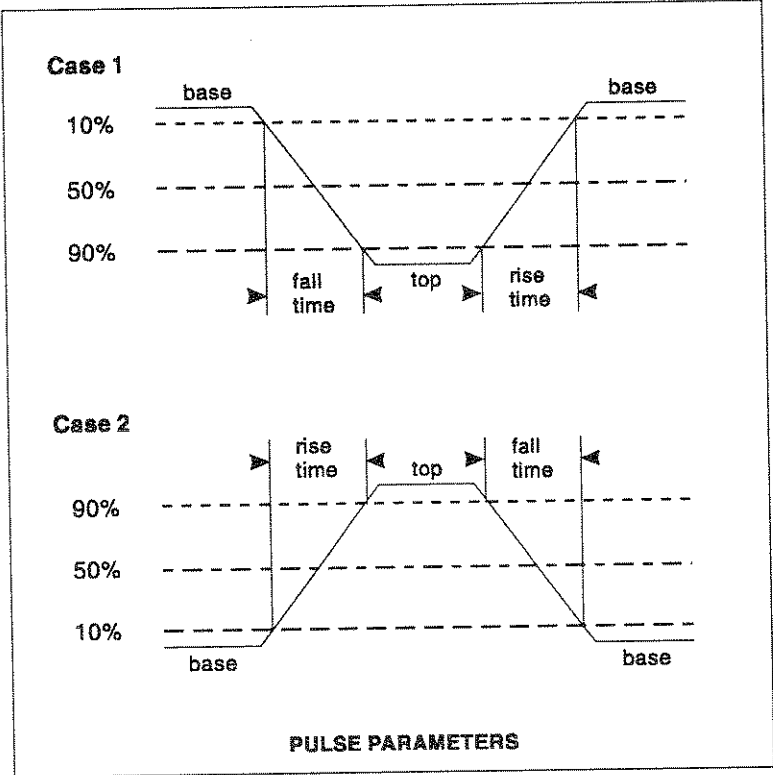

**Mean** determines the average value of all the data points selected as described above.

$$\frac{1}{N} \sum_{i=1}^N v_i$$

**Standard Deviation (Sdev)** is the standard deviation of the measured points from the mean. It is calculated from the following formula:

$$\sqrt{\frac{1}{N-1} \sum_{i=1}^N (v_i - \text{mean})^2}$$

**RMS** is derived from the square root of the average of the squares of the magnitudes, for all the data as described above.

$$\sqrt{\frac{1}{N} \sum_{i=1}^N (v_i)^2}$$

The **Area** covered by the signal is computed from the sum over all the data points selected, as described above, times the sample interval.

## TIME MEASUREMENTS

*Note: For time measurements it is necessary to distinguish between magnitude crossings occurring on leading edges and those occurring on trailing edges. In the equations below the following notation has been used:*

$M_l$  = number of leading edges found

$M_t$  = number of trailing edges found

$Tl_i^x$  = time when leading edge  $i$  crosses the  $x\%$  level

$Tt_i^x$  = time when trailing edge  $i$  crosses the  $x\%$  level

*All times are linearly interpolated between two measured points.*

**Period** is calculated from the average length of the full periods of the waveform within the selected interval. A full period is the time measured between the first and third 50% crossing points, the third and fifth, the fifth and seventh, etc.

$$\frac{1}{M_l - 1} \sum_{i=1}^{M_l - 1} (Tl_{i+1}^{50} - Tl_i^{50})$$

**Frequency** is then calculated as 1/Period.

**Cycles** gives the number of periods found.



## APPENDIX D

**Pulse Width (Width)** determines the duration between the **Pulse Start** (mesial point, i.e. the 50% magnitude transition point, on the leading edge) and the **Pulse Stop** (mesial point on the trailing edge) of a pulse waveform. Like the pulse start, the pulse stop is a 50% magnitude reference point.

$$\frac{1}{Mt} \sum_{i=1}^{Mt} (Tt_i^{50} - Tl_i^{50})$$

**Delay** is the time from the trigger point to the first 50% transition crossing, i.e. the **Pulse Start**.

$$Tl_i^{50}$$

**Duty Cycle** measures the Pulse Width as a percentage of the Pulse Period.

**Risetime (Rise)** measures the time of a pulse waveform's transition with a positive slope.

**Falltime (Fall)** measures the time of a pulse waveform's transition with a negative slope.

For both risetime and falltime measurements the instrument determines the duration between the proximal point (10% magnitude transition) and the distal point (90% magnitude transition) on leading edges and the duration between the distal point and the proximal point on trailing edges:

leading edge duration =

$$\frac{1}{Ml} \sum_{i=1}^{Ml} (Tl_i^{90} - Tl_i^{10})$$

trailing edge duration =

$$\frac{1}{Mt} \sum_{i=1}^{Mt} (Tt_i^{10} - Tt_i^{90})$$

Depending on the sign of the slope of the leading edge transition, the instrument then assigns either:

for positive slope:	Risetime	=	leading edge duration
	Falltime	=	trailing edge duration
for negative slope:	Risetime	=	trailing edge duration
	Falltime	=	leading edge duration

**A**

Acquisition  
Memory length, 10-2  
Number of points, 10-1; C-2; C-4; C-11  
Record length, 10-2  
RIS (Random Interleaved Sampling), 3-3;  
8-1; 9-1; 10-1; 11-5; 11-12; 11-17; A-2  
Roll mode, 8-1; 8-3; 9-1; 9-2  
Sequence mode, 8-1; 8-3; 9-2; 10-1; 16-1;  
18-2; 19-16; A-2  
Single-shot, 8-1; 9-2; 10-1; A-2  
Summary, 6-1, 24-1  
AUTO button, 9-1  
AUTO SETUP button, 9-2; A-4

**B**

Bandwidth Limit filter, 13-1

**C**

Channels  
Controls, 12-1  
Pairing, 10-2  
CLEAR SWEEPS button, 16-5; 16-8; 16-11;  
17-3; 18-5; 22-9  
Clock signals, 10-5  
Combining multiple Functions, 14-2  
Controls  
Channels, 12-1  
Display, 7-3; 17-2; 18-1  
Front-Panel, 5-1  
Menu Buttons, 6-1; 11-1; 17-1  
Timebase & Trigger, 9-1  
COUPLING button, 13-1  
Cursors  
Absolute, 22-7  
Amplitude, 22-7  
Diff, Ref, 22-7  
General

Standard Display, 22-1  
XY Display, 22-1  
In FFT, C-3  
Parameter & PASS/FAIL, 22-9; 22-16  
Relative, 22-7  
Time, 22-7  
Behavior, 19-14  
Tracking cursors, 22-7

**D**

DELAY knob, 9-3  
Display  
Controls, 7-3; 17-2; 18-1  
grids, 18-1; 18-5  
persistence, 18-1  
XY, 18-1; 18-3; 18-6; 22-1  
DISPLAY button, 7-3; 17-2; 18-1

**E**

External clock, 10-5

**F**

Features (Key), 1-1  
FIND button, 12-1; 12-3

**H**

Holdoff (Trigger), 8-5; 8-7; 11-2; 11-21

**L**

Level (Trigger), 5-1; 7-1; 8-3; 8-5; 9-2; 11-1;  
11-4; 11-13; 11-19; 11-21; 17-1; 19-17; 22-4;  
22-7; 22-13; A-2; D-3  
LEVEL knob, 9-3  
Low-pass filter, 13-1

## INDEX

### M

- Math Functions
  - Set Up, 14-2;
  - SPEED-UP, 14-3; 16-2
- MATH SETUP button, 14-1; 15-2; 16-1
- Measurement (Automatic Parameter-), 22-8; 22-11; A-5
  - Custom, 22-11
  - Definitions, D-1
  - Parameter list, 22-4
  - Standard Time, 22-10
  - Standard Voltage, 22-9
  - Statistics, 22-8; 22-11; A-5
  - Symbols, 22-6
- Memory Used summary, 24-5
- Menu Buttons
  - Controls, 6-1; 11-1; 17-1
- Message Field, 7-3

### O

- Offset behavior, 9-2; 10-2; 12-1; 12-4; 15-2; 19-1; 19-16
- OFFSET knob, 12-1
- Operating Environment, 4-1
- Overload, 4-1; 13-1; 13-3

### P

- PASS/FAIL
  - General, 1-1; 17-3; 19-17; 22-8; 22-15; 22-19
  - Mask Limits, 22-20
  - Mask Recalling, 22-21
  - Parameter Selection, 22-17
  - Top Menu, 22-16
- Peak Detect, 8-2, 10-2
- POSITION knob, A-6; B-2
- Power On, 3-4; 4-2
- Power Requirements, 4-1
- Power-On Self-Test, 4-2

### Probe

- Attenuation, 13-1; A-1
- Calibrator, 13-3
- Coupling, 13-3
- ProBus, 13-2
- Supplied Probes, 13-3; A-6
- Passive probes, 13-3; A-6

### R

- Recall
  - Setup, 23-2
  - Waveform, 17-2; 22-20
- RESET (GENERAL INSTRUMENT), 6-3
- RESET button, 15-2

### S

- Safety, 4-1
- Sampling rate, 8-1; 10-1; 10-3; 11-5; A-1; B-1
- Sequence mode, 10-3
- Service
  - Customer support, 2-1
  - Maintenance, 2-2
  - RAN (Return Authorization Number), 2-2
  - Repair procedures, 2-2
- SHOW STATUS Button, 6-1
- Slope (Trigger), 3-3; 7-2; 8-5; 11-2; 11-18; A-2; D-4; D-5
- SNGL button, 9-2
- Specifications, A-1
  - Bandwidth, A-1
  - Clock accuracy, A-2
  - DC accuracy, A-1
  - Dimensions, A-7
  - Input impedance, A-1
  - Maximum voltage, A-1
- Memory
  - Acquisition, A-1
- Options
  - Hardware, A-6
  - Processing, A-6

## INDEX

Sensitivity (V/div) range, 5-1; A-1  
 Shock and Vibration, A-6  
 Supported printers/plotters, A-3  
 Timebase  
   Interpolator accuracy, A-2  
   Interpolator resolution, A-2  
   Range, A-2  
 Trigger  
   External trigger input, A-2  
   External trigger range, A-2  
   Post-trigger range, 9-3; A-2  
   Pre-trigger range, A-2  
   Rate, A-2  
   Trigger (SMART), A-3  
   Weight, A-7  
 STOP button, 9-1  
 Storage  
   Setup, 3-1; 3-4; 17-2; 23-1  
   Waveform, 17-2; 20-1  
     Auto-Store, 17-2; 20-1  
 Sweeps, 16-1; 16-5; 16-8; 16-11; 17-3; 18-5;  
 18-6; 22-8; 22-11; 22-15  
 System summary, 24-2

**T**

Text & Times summary, 24-3  
 Time span, 10-1; 22-1  
 TIME/DIV knob, 9-3  
 Timebase & Trigger  
   Controls, 9-1  
 TIMEBASE SETUP button, 10-1  
 Trace  
   expansion or zoom, 16-3  
   Viewing Memories, 14-1; 20-1; 21-1  
 TRACE ON/OFF button, 12-1; 12-3; 15-1  
 Trigger  
   Delay, 9-3  
   Dropout, 8-5; 11-17  
   Edge, 8-5; 8-7; 11-1; 11-14  
   Glitch, 1-1; 11-5  
   Interval, 11-8

Pattern, 8-5; 11-7; 11-19  
 Pulse Width, 1-1; 11-5; 11-6; 11-7; 11-8  
 Qualified, 11-10; 11-13; 11-15  
 Symbols, 11-3; 11-22  
 TV, 11-10  
 Trigger (SMART), 11-1; 11-2; 11-4; 11-22;  
 A-3  
 TRIGGER SETUP button, 11-1

**U**

Utilities  
   CAL BNC control, 19-17  
   Floppy disk, 19-1  
     Available space, 19-1  
     Copying and formatting, 19-1  
     File Listing, 19-1  
     File Naming Conventions, 19-10  
     File Reorder, 19-14  
     Interleave factor, 19-14  
     Structure, 19-10  
   Hardcopy  
     RS-232-C cabling, 19-2  
   Hardcopy setup, 19-2  
   Internal printer setup, 19-2; 19-3; A-6  
   Memory Card, 19-1  
     Available space, 19-1  
     Battery, 19-10  
     Copying and Formatting, 19-1  
     File Listing, 19-1  
     File Naming Conventions, 19-10  
     Structure, 19-10  
     Write protect switch, 19-10  
   Special Modes, 9-2; 10-2; 12-1; 12-4;  
   15-2; 19-1; 19-16  
   Time and Date adjustment, 19-4  
 UTILITIES button, 9-2; 10-2; 17-2; 19-1

**V**

VAR button, 12-2; 12-4  
 VOLTS/DIV knob, 12-1; 12-4

**INDEX****W**

Warranty, 2-1; 2-2; A-7  
Waveform summary, 24-4  
Waveform Processing (frequency), 14-2;  
16-1; A-6; B-2; C-1  
    FFT Algorithm, C-4  
    FFT averaging example, C-8  
    FFT example, C-7  
    FFT Window, C-2; C-6; C-9; C-13  
Waveform Processing (time), 14-2; 16-1; A-6  
    Digital Filtering  
        Example, B-4  
    Enhanced Resolution, B-1  
        Example, B-5  
    Envelope, 16-8  
    Extrema, 16-8  
    Low-pass Filtering  
        Example, B-4  
    Noise Reduction  
        Example, B-6

**Z**

ZERO button, 9-3  
Zoom  
    Math Functions, 14-3  
    Multi-Zoom, 14-1; 14-2; 15-2; 16-1; 16-2  
    ZOOM knobs, 20-1; 21-1

# 2-CHANNEL FRONT-PANEL

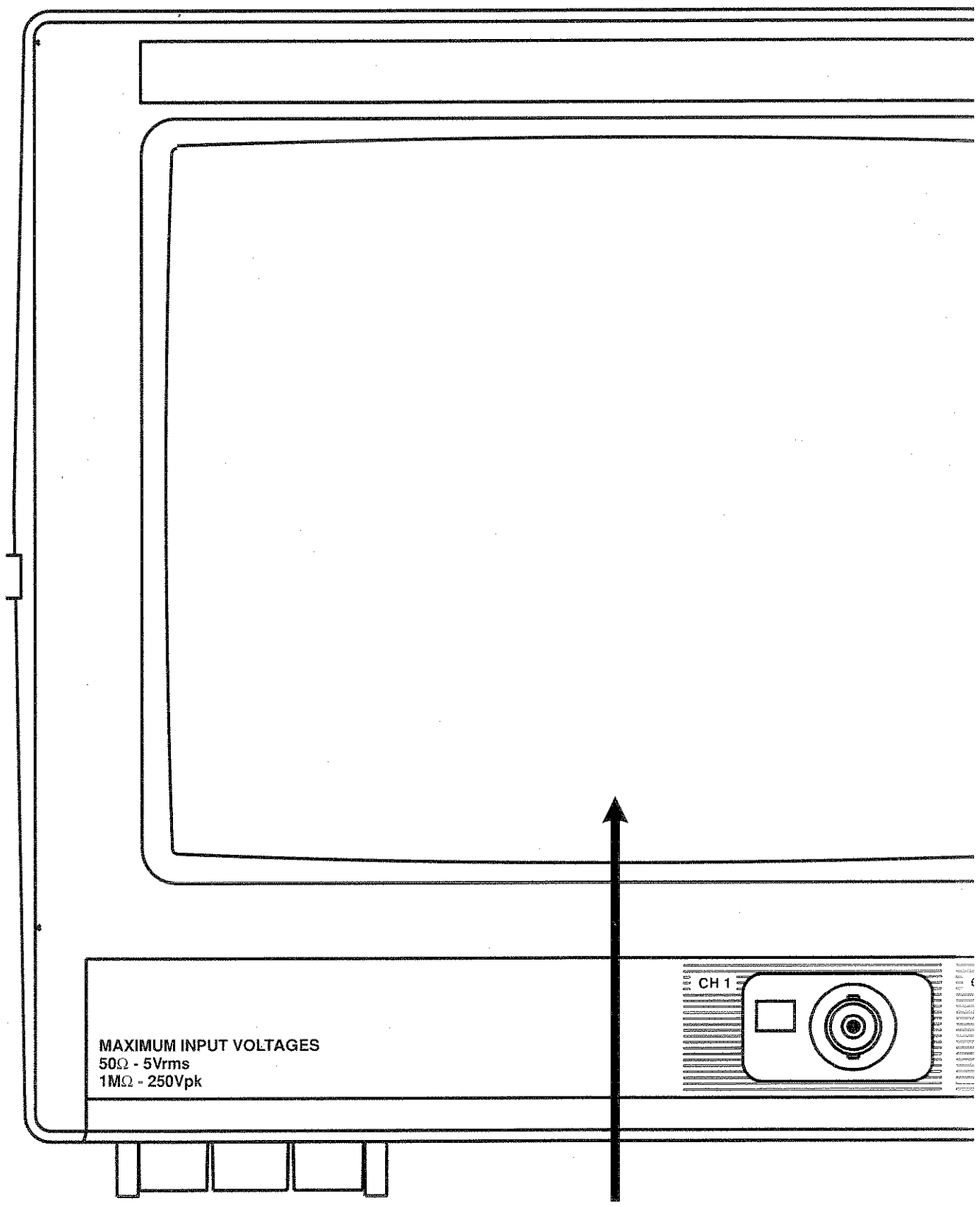

MAXIMUM INPUT VOLTAGES  
50Ω - 5Vrms  
1MΩ - 250Vpk

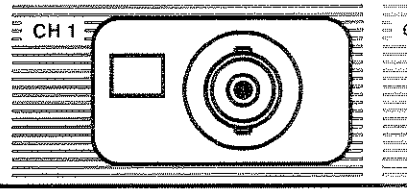

DISPLAY

# TIMEBASE & TRIGGER CONTROLS

# CHANNEL CONTROLS

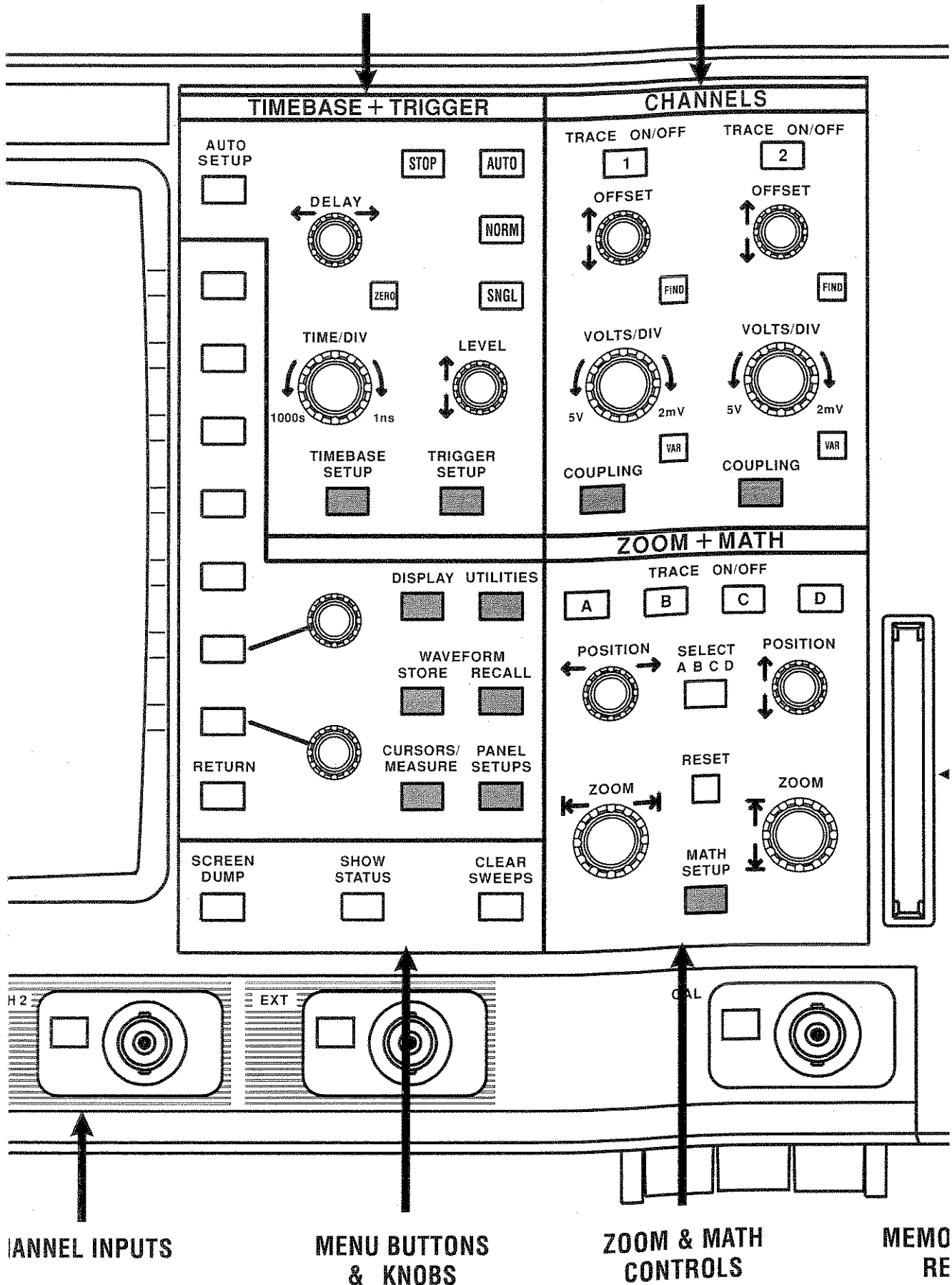

CHANNEL INPUTS

MENU BUTTONS & KNOBS

ZOOM & MATH CONTROLS

MEMO RE



# REAR PANEL

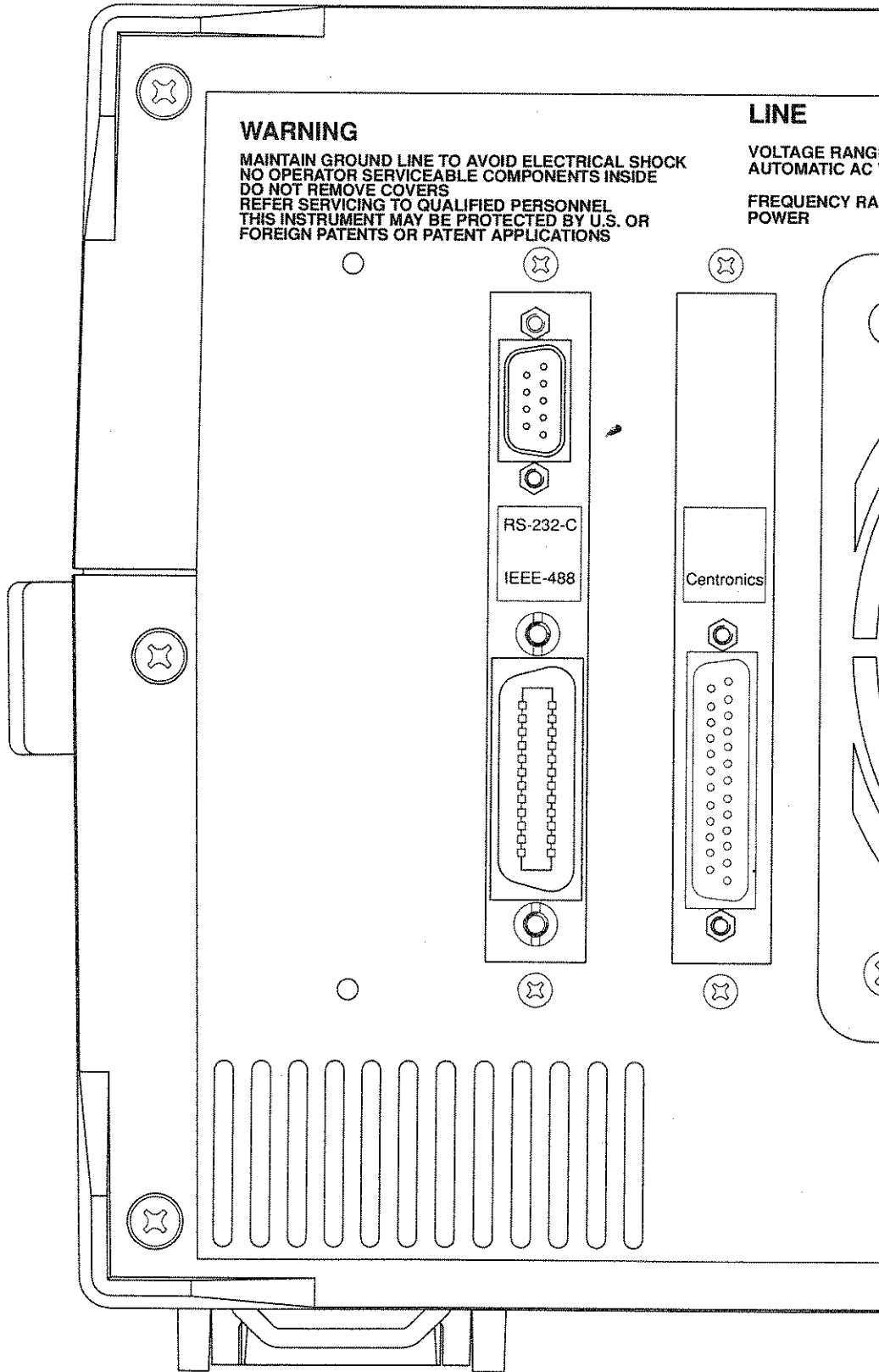

## WARNING

MAINTAIN GROUND LINE TO AVOID ELECTRICAL SHOCK  
NO OPERATOR SERVICEABLE COMPONENTS INSIDE  
DO NOT REMOVE COVERS  
REFER SERVICING TO QUALIFIED PERSONNEL  
THIS INSTRUMENT MAY BE PROTECTED BY U.S. OR  
FOREIGN PATENTS OR PATENT APPLICATIONS

## LINE

VOLTAGE RANGE:  
AUTOMATIC AC

FREQUENCY RANGE:  
POWER

RS-232-C

IEEE-488

Centronics

# FUSE

250V/5A NORMAL BLOWING  
FOR CONTINUED FIRE PROTECTION REPLACE ONLY  
WITH THE SPECIFIED TYPE AND RATING OF FUSE  
DISCONNECT POWER CORD BEFORE REPLACING FUSE

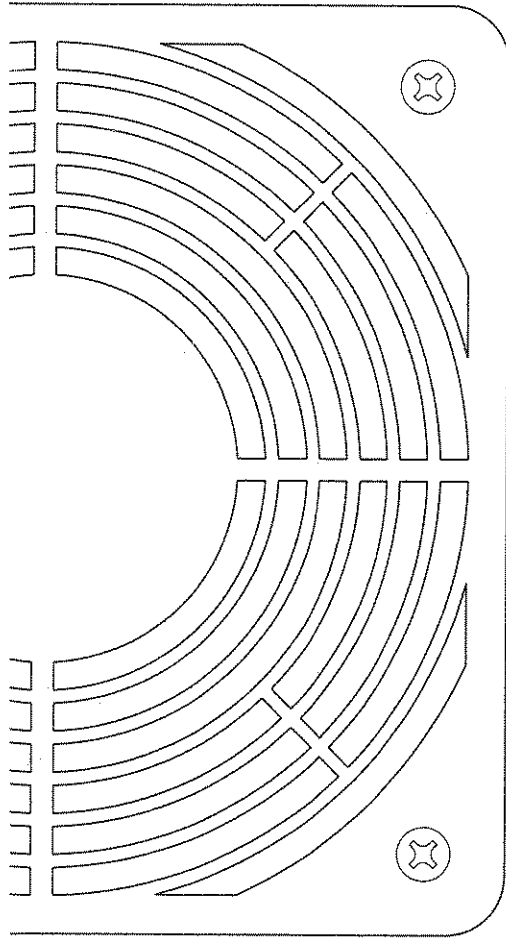

POWER ON/OFF  
FUSE

